

DAEWOO

Service Manual

XGA COLOR MONITOR

Model : 710B



DAEWOO ELECTRONICS CO., LTD
OVERSEAS SERVICE DEPT.

CONTENTS

SAFETY PRECAUTIONS	1
GENERAL SAFETY INFORMATION	2
SERVICING PRECAUTIONS	3
TECHNICAL INFORMATION	6
GENERAL INFORMATION	7
PIN CONNECTOR	8
CAUTIONS FOR ADJUSTMENT AND REPAIR	8
OPERATION & ADJUSTMENT	9
TROUBLESHOOTING HINTS	15
ALIGNMENT PROCEDURE	31
BLOCK DIAGRAM	33
PCB LAYOUT	34
SCHEMATIC DIAGRAM	37
EXPLODED VIEW DIAGRAM	38
REPLACEMENT PARTS LIST	39
CIRCUIT BOARD ELECTRICAL PARTS LIST	40

SAFETY PRECAUTIONS

CAUTION: No modifications of any circuit should be attempted. Service work should only be performed after you are thoroughly familiar with all of the following safety check and servicing guidelines.

Safety Check

Care should be taken while servicing this analog color display because of the high voltages used in the deflection circuits. These voltages are exposed in such areas as the associated flyback and yoke circuits.

Fire & Shock Hazard

- Insert an isolation transformer between the analog color display and AC power line before servicing chassis.
- In servicing, pay attention to original lead dress especially in the high voltage circuit. If a short circuit is found, replace all parts which have been overheated as a result of the short circuit.
- All the protective devices must be reinstalled per original design.
- Soldering must be inspected for possible cold solder points, frayed leads, damaged insulation, solder splashes or sharp solder points. Be certain to remove all foreign materials.

Implosion Protection

Picture tube in this monitor employs integral implosion protection system, but care should be taken to avoid damage and scratching during installation.

Use only same type replacement picture tubes.

IMPORTANT SAFETY NOTICE: There are special components used in analog color display, which are important for safety. These parts are shaded on the schematic diagram and on the replacement parts list. It is essential that these critical parts should be replaced with manufacturer's specified parts to prevent X-radiation, shock, fire or other hazards. Do not modify the original design without getting a written permission from DAEWOO ELECTRONICS CO. or this will void the original parts and labor warranty.

X-Radiation

WARNING: The only potential source of X-Radiation is the picture tube. However when the high voltage circuitry is operating properly, there is no possibility of an X-Radiation problem. The basic precaution which must be exercised is to keep the high voltage at the following factory recommended level.

NOTE: It is important to use an accurate, periodically calibrated high voltage meter.

- To measure the high voltage, use a high-impedance high-voltage meter. Connect (-) to chassis and (+) to the CRT anode button.
- Turn the Contrast & brightness control fully counterclockwise.
- Measure the high voltage. The high voltage meter should indicate the following factory recommended level.
- If the upper meter indication exceeds the maximum level, immediate service is required to prevent the possibility of premature component failure.
- To prevent X-Radiation possibility, it is essential to use the specified picture tube.
- The normal high voltage is 26.5KV or below, and must not exceed 29KV at zero beam current at rated voltage.

GENERAL SAFETY INFORMATION

Terms in the manual

- CAUTION** Statements identify conditions or practices that could result in damage to the equipment or other property.
- WARNING** Statements identify conditions or practices that could result in personal injury or loss of life.

Terms as marked on equipment

- CAUTION** Statements indicate a personal injury hazard not immediately accessible as one reads the marking, or a hazard to properly including the equipment itself.
- WARNING** Statements indicate a personal injury hazard immediately accessible as one reads the marking

Symbols in the manual

This symbol indicates where applicable cautionary or other information is to be found.

Symbols as marked on equipment

Protective GROUND terminal



High Voltage Warning And Critical Component Warning Label
Following warning label is on the CRT PWB shield case inside the unit.

Warning: This product includes critical mechanical and electrical parts which are essential for x radiation safety. For continued safety, replace critical components indicated in the service manual only with exact replacement parts given in the parts list. Operating high voltage for this product is 29Kv at minimum brightness. Refer to service manual for measurement procedures and proper service adjustments.

SERVICING PRECAUTIONS

CAUTION: Before servicing instruments covered by this service manual, its supplements and addendum, read and follow the SAFETY PRECAUTIONS of this manual.

NOTE: If unforeseen circumstances create conflict between the following servicing precautions and any of the safety precautions on page 1 of this manual, always follow the safety precautions.
Remember: Safety First.

General Servicing Precautions

1. Always unplug the AC power cord from the AC power source before:
 - a. Removing or reinstalling any component, circuit board, module, or any other instrument assembly.
 - b. Disconnecting or reconnecting any electrical plug or other electrical connection.
 - c. Connecting a test substitute in parallel with an electrolytic capacitor in the instrument.

CAUTION: A wrong part substitution or incorrect polarity installation of electrolytic capacitors may result in a explosion hazard.

- d. Discharging the picture tube anode.
2. Test high voltage only by measuring it with an appropriate high voltage meter or other voltage measuring device (DVM, FETVOM. etc.) equipped with a suitable high voltage probe. Do not test high voltage by “drawing an arc”.
3. Discharge the picture tube anode only by: (a) first connecting one end of an insulated clip lead to the degaussing or line grounding system shield at the point where the picture tube socket ground lead is connected, and then (b) touching the other end of the insulated clip lead to the picture tube anode button, using an insulating handle to avoid personal contact with high voltage.
4. Do not any spray chemicals on or near this instrument or any of its assemblies.
5. Unless specified otherwise in this service manual, clean electrical contacts by applying the following mixture to the contacts with a pipe cleaner, cotton-tipped stick or comparable nonabrasive applicator: 10% (by volume) Acetone and 90% (by volume) isopropyl alcohol (90%-99% strength).

CAUTION: This is a flammable mixture. Unless specified otherwise in this service manual, lubrication of contacts is not required.

6. Do not defeat any plug/socket B+ voltage interlocks with which instruments covered by this service manual might be equipped.
7. Do not apply AC power to this instrument and/or any of its electrical assemblies unless all solid-state device heat sinks are correctly installed.
8. Always connect the test instrument ground lead to the appropriate instrument chassis ground before connecting the test instrument positive lead. Always remove the test instrument ground lead last.
9. Use only the test fixtures specified in this service manual with this instrument.

CAUTION: Do not connect the test fixture ground strap to any heatsink in this instrument.

Electrostatically Sensitive (ES) Devices

Some semiconductor (solid state) devices can be damaged easily by static electricity.

Such components commonly are called Electrostatically Sensitive (ES) Devices.

The examples of typical ES devices are integrated circuits, some field-effect transistors and semiconductor “chip” components. The following techniques should be used to help reduce the incidence of component damage caused by static electricity.

1. Immediately before handling any semiconductor component or semiconductor-equipped assembly, drain off any electrostatic charge on your body by touching a known earth ground. Alternatively, obtain and wear a commercially available discharging wrist strap device which should be removed for potential shock reasons prior to applying power to the unit under test.
2. After removing an electrical assembly equipped with ES devices, place the assembly on a conductive surface such as aluminum foil to prevent electrostatic charge buildup or exposure of the assembly.
3. Use only a grounded-tip soldering iron to solder or unsolder ES devices.
4. Use only an anti-static type solder removal device. Some solder removal devices not classified as “anti-static” can generate enough electrical charges to damage ES devices.
5. Do not use freon-propelled chemicals. These can generate enough electrical charges to damage ES devices.
6. Do not remove a replacement ES device from its protective package until immediately before you are ready to install it. (Most replacement ES devices are packaged with leads electrically shorted together by conductive foam, aluminum foil or comparable conductive material).
7. Immediately before removing the protective material from the leads of a replacement ES device, touch the protective material to the chassis or circuit assembly into which the device will be installed.

CAUTION: Be sure that no power is applied to the chassis or circuit, and observe all other safety precautions.

8. Minimize bodily motions when handling unpackaged replacement ES devices. (Otherwise harmful motion such as the brushing together of your clothes fabric or the lifting of your foot from a carpeted floor can generate enough static electricity to damage an ES devices).

General Soldering Guidelines

1. Use a grounded-tip, low-wattage soldering iron with appropriate tip size and shape that will maintain tip temperature within a 550°F-660°F (288°C-316°C) range.
2. Use an appropriate gauge of RMA resin-core solder composed of 60 parts tin/40 parts lead.
3. Keep the soldering iron tip clean.
4. Thoroughly clean the surface to be soldered. Use a small wire-bristle (0.5 inch or 1.25cm) brush with a metal handle. Do not use freon-propelled spray-on cleaners.
5. Use the following soldering technique:
 - a. Allow the soldering iron tip to reach normal temperature (550°F to 660°F or 288°C to 316°C)
 - b. Hold the soldering iron tip and solder strand against the component lead until the solder melts.
 - c. quickly move the soldering iron tip to the junction of the component lead and the printed circuit foil, and hold it there only until the solder flows onto and around both the component lead and the foil.
 - d. Closely inspect the solder area and remove any excess or splashed solder with a small wire-bristle brush.

CAUTION: Work quickly to avoid overheating the circuit board printed foil.

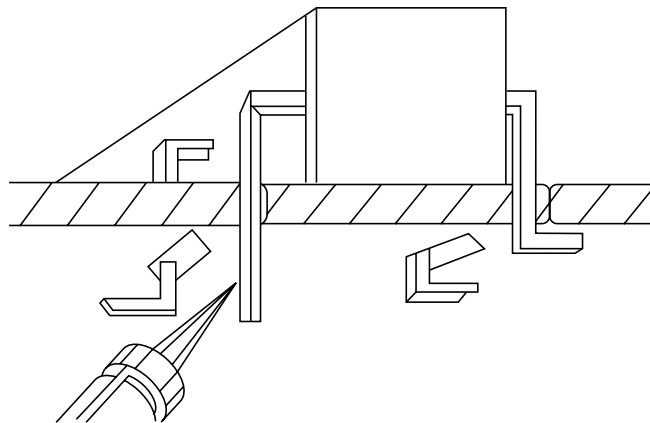

FIGURE 1. USE SOLDERING IRON TO PRY LEADS

IC Removal/Replacement

Some utilized chassis circuit boards have slotted (oblong) holes through which the IC leads are inserted and then bent flat against the circuit foil. When holes are slotted, the following technique should be used to remove and replace the IC. When working with boards using the familiar round hole, use the standard technique as outlined in paragraphs 5 on the page under the title of general soldering guidelines.

Removal

1. Desolder and straighten each IC lead in one operation by gently prying up on the lead with the soldering iron tip as the solder melts.
2. Draw away the melted solder with an anti-static suction-type solder removal device (or with desoldering braid before removing the IC).

Replacement

1. Carefully insert the replacement IC in the circuit board.
2. Carefully bend each IC lead against the circuit foil pad and solder it.
3. Clean the soldered areas with a small wire-bristle brush. (It is not necessary to reapply acrylic coating to the area).

“Small-Signal” Discrete Transistor Removal/Replacement

1. Remove the defective transistor by clipping its leads as close as possible to the component body.
2. Bend the end of each of three leads remaining on the circuit board into a “U” shape.
3. Bend the replacement transistor leads into a “U” shape.
4. Connect the replacement transistor leads to the corresponding leads extending from the circuit board and crimp the “U” with long nose pliers to insure metal-to-metal contact, then solder each connection.

Power IC, Transistor or Devices Removal/Replacement

1. Heat and remove all solders from the device leads.
2. Remove the heatsink mounting screw (if applicable).
3. Carefully remove the device from the circuit board.
4. Insert new device in circuit board.
5. Solder each device lead, and clip off excess lead.
6. Replace heatsink.

Diode Removal/Replacement

1. Remove defective diode by clipping its leads as close as possible to diode body.
2. Bend the two remaining leads perpendicularly to the circuit board.
3. Observing diode polarity, wrap each lead out of the new diode around the corresponding lead on the circuit board.
4. Securely crimp each connection and solder it.
5. Inspect the solder joints of the two "original" leads on the circuit board copper side. If they are not shiny, reheat them and apply additional solder if necessary.

TECHNICAL INFORMATION

Picture Tube

Type : 17-inch, Flat Square Tube type
(16.2-inch, viewing area)
Dot Pitch : 0.28mm
Face Treatment : Non-glare / Anti-static

Video

Input Signal : R.G.B Analog
Amp. Bandwidth : 85 MHz
Input Sync : TTL, separate negative / positive

Scan Frequency

Horizontal : 30-69 KHz
Vertical : 50-160 Hz

Max. Resolution

1280 dots X 1024 lines (at 60Hz)

Power Source

Free Voltage (100-240 Vac, 50/60Hz)

Display Area

Standard Display Area : 310mm(H)X232mm(V)
Full Screen Size : 330mm(H)X250mm(V)

Power Consumption

Max. 100W

State	Recovery Time	Power LED
On	None	Green
Stand-by Suspend	3 seconds	Green : 1 second Amber : 0.5 second
Off	7 seconds	Amber

Dimension

424(W)X440(H)X447.2(D)mm
(set with stand)

Weight (Net/Gross)

16.8/19.7 kg

Operating Environment

Temperature : 10-40°C/50-104°F
Relative Humidity : 8-80%

Storage Environment

Temperature : -20-45°C/-4-113°F
Relative Humidity : 5-90%

GENERAL INFORMATION

This color monitor automatically scans all horizontal frequencies from 30KHz to 69KHz, and all vertical frequencies from 50Hz to 160Hz. This color monitor adopted the OSD (On Screen Display), it shows the sync polarity and frequency and it provides that easily adjust control. This color monitor supports IBM PC, PC/XT, PC/AT, personal System/2 (PS/2), Apple Macintosh, and compatible users crisp text and vivid color graphics display when using the following graphics adapters : (VGA, 8514/A, Super VGA, VESA and XGA and Apple Macintosh Video Card). And so, this color monitor has a maximum horizontal resolution of 1280 dots and a maximum vertical resolution of 1024 lines for superior clarity of display.

By accepting analog signal inputs which level is zero to 0.7 Volts. This color monitor can display and unlimited palette of colors depending on the graphics adapter and software being used.

Abbreviations

ADJ	Adjustment
AFC	Automatic Frequency Control
CRT	Cathode Ray Tube
Def	Deflection
D.Y	Deflection Yoke
FBT	Flyback Transformer
H.SYNC	Horizontal Synchronization
OSC	Oscillator
P.S.U	Power Supply Unit
PWA	Printed Circuit Board Wiring Assembly
R.G.B	Red, Green, Blue
V.Sync	Vertical Synchronization

PIN CONNECTOR

Pin	Signal
1	Red
2	Green
3	Blue
4	GND
5	GND
6	GND - Red
7	GND - Green
8	GND - Blue
9	Reserved
10	GND - H.Sync
11	GND
12	Bi-directional Data (SDA)
13	Horizontal Sync
14	Vertical Sync (VCLK)
15	Data Clock (SCL)

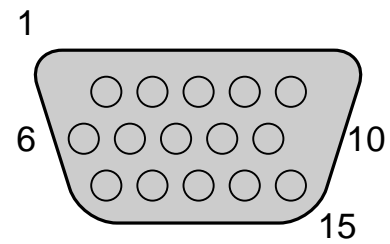

Arrangement of 15-pin D-sub connector

CAUTIONS FOR ADJUSTMENT AND REPAIR

- Degaussing is always required when adjusting purity or convergence.
- The white balance adjustment has been done by a color analyzer in factory. The adjustment procedure, described in the service manual is made by a visual check.
- Allow 20 minutes warm-up time for the display before checking or adjusting only electrical specification or function.
- Reform the leadwire after any repair work.





Caution For Servicing

- In case of servicing or replacing CRT, high voltage sometimes remains in the anode of the CRT. Completely discharge high voltage before servicing or replacing CRT to prevent a shock to the serviceman.

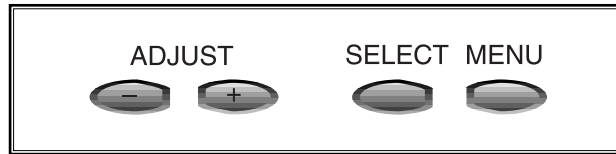
OPERATION & ADJUSTMENT

ADJUSTMENT KEY







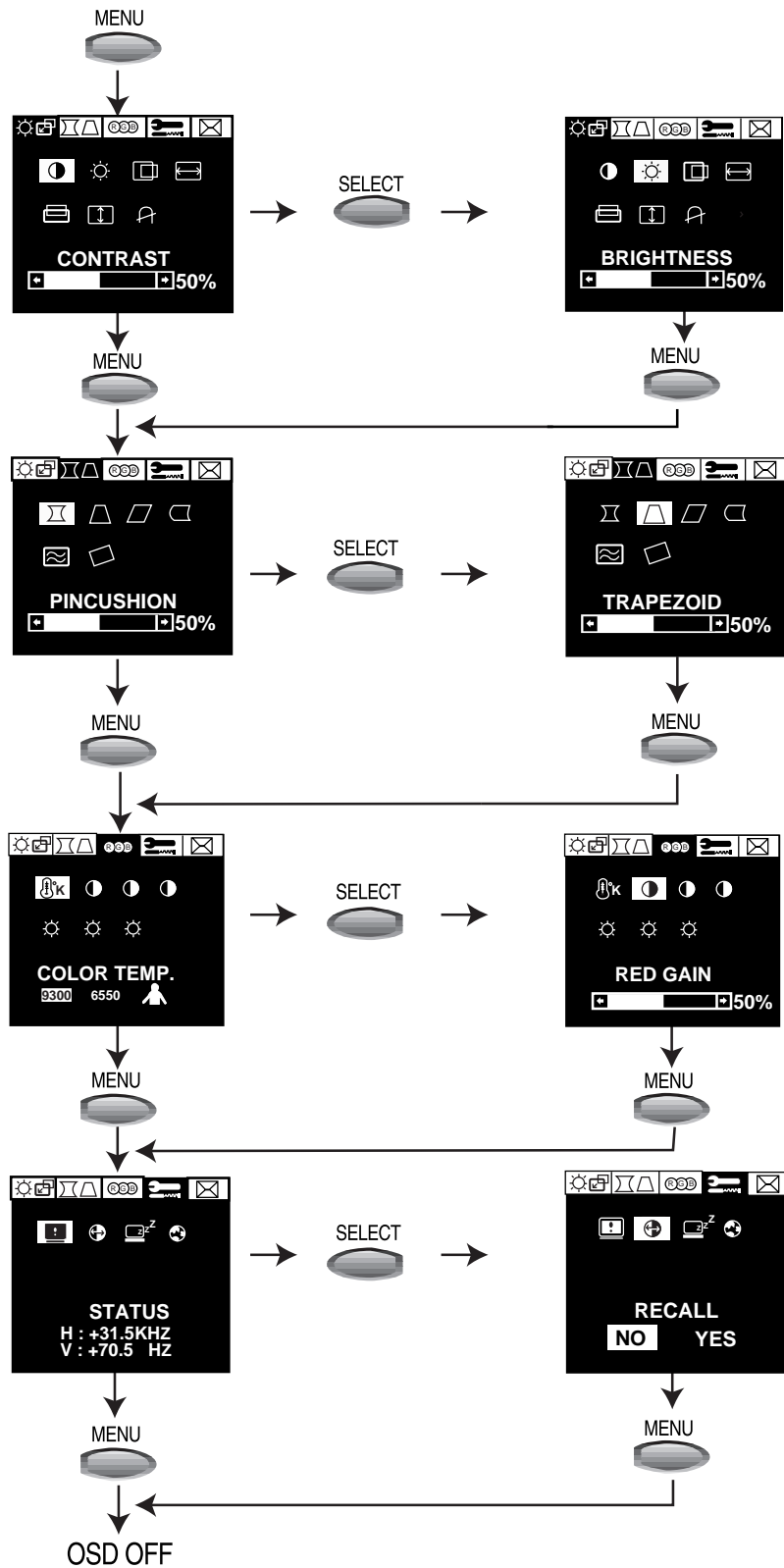

MENU 	Launch OSD(On-Screen Display) menus
SELECT 	Select the next function
ADJUST 	Increase the value of any selected function
ADJUST 	Decrease the value of any selected function

ADJUSTMENT PROCESS





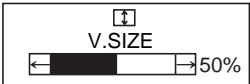



























When you choose the icon  on the OSD window, you can exit the OSD screen.







OSD(On-Screen Display) Menu 1

	<p>Adjust the contrast of image, the difference between light and dark areas on the screen. Range : 0-100%</p>
	<p>Adjust the brightness of the entire display.</p>
	<p>Adjust the position of the display horizontally (left or right).</p>
	<p>Adjust the display width (horizontal size).</p>
	<p>Adjust the position of the display vertically (up or down).</p>
	<p>Adjust the display height (vertical size).</p>
	<p>Degauss the display and restore image quality.</p>





OSD(On-Screen Display) Menu 2

 <p>PINCUSHION</p>	<p>Adjust the left and right margins for more convex or more concave margins.</p> <ul style="list-style-type: none"> • Image turns to  by . • Image turns to  by .
 <p>TRAPEZOID</p>	<p>Adjust the trapezoid of the screen by moving the lines inward or outward.</p> <ul style="list-style-type: none"> • Image turns to  by . • Image turns to  by .
 <p>PARALLELOGRAM</p>	<p>Adjust parallelogram when the screen is leaning left or right.</p> <ul style="list-style-type: none"> • Image turns to  by . • Image turns to  by .
 <p>PIN BALANCE</p>	<p>Adjust the side balance when the sides of the screen are bowed towards left or right.</p> <ul style="list-style-type: none"> • Image turns to  by . • Image turns to  by .
 <p>V. MOIRE</p>	<p>Adjust the vertical picture moire cancellation.</p> <ul style="list-style-type: none"> • Image turns to  by . • Image turns to  by .
 <p>ROTATION</p>	<p>Adjust the rotation when the screen is tilted left or right(Optional).</p> <ul style="list-style-type: none"> • Image turns to  by . • Image turns to  by .

OSD(On-Screen Display) Menu 3

 <p>COLOR TEMP 9300 6550</p>	<p>Choose different preset color temperatures or set your own customized color parameters.</p>
 <p>RED GAIN</p> <p>← [] → 50%</p>	<p>Adjust the red gain.</p>
 <p>GREEN GAIN</p> <p>← [] → 50%</p>	<p>Adjust the green gain.</p>
 <p>BLUE GAIN</p> <p>← [] → 50%</p>	<p>Adjust the blue gain.</p>
 <p>RED BIAS</p> <p>← [] → 50%</p>	<p>Adjust the red bias.</p>
 <p>GREEN BIAS</p> <p>← [] → 50%</p>	<p>Adjust the green bias.</p>
 <p>BLUE BIAS</p> <p>← [] → 50%</p>	<p>Adjust the blue bias.</p>

OSD(On-Screen Display) Menu 4

 <p>STATUS H : +31.5KHZ V : +70.5 HZ</p>	<p>Display horizontal & vertical frequency and polarity.</p>
 <p>RECALL NO YES</p>	<p>Reset the screen to the Factory Preset Display Settings.</p>
 <p>POWER SAVER NO YES</p>	<p>YES : VESA DPMS operation. NO : NO DPMS operation.</p>
 <p>LANGUAGE ENGLISH DEUTSCH ESPAÑOL FRANÇAIS ITALIANO</p>	<p>Select language for OSD.</p>

Self Diagnosis

When the monitor doesn't display, if you press any key, Self Diagnosis screen is displayed. Self Diagnosis function checks if the status of the monitor is No Signal or Out of range.

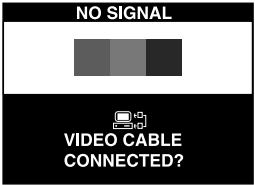
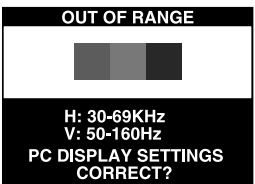
 <p>The image shows a screen with a black background. At the top, the text "NO SIGNAL" is displayed in white. Below this, there is a horizontal bar with three segments of varying shades of gray. At the bottom, there is a white icon of a monitor and a cable, followed by the text "VIDEO CABLE CONNECTED?" in white.</p>	<p>No Signal screen is displayed when the D-Sub signal connector is not connected or the status of the monitor is on DPMS mode.</p>
 <p>The image shows a screen with a black background. At the top, the text "OUT OF RANGE" is displayed in white. Below this, there is a horizontal bar with three segments of varying shades of gray. At the bottom, the text "H: 30-69KHz" and "V: 50-160Hz" is displayed in white, followed by "PC DISPLAY SETTINGS CORRECT?" in white.</p>	<p>Out of Range screen is displayed when the applied frequency is under or over normal range.</p> <ul style="list-style-type: none">■ Normal range H : 30-69 KHz V : 50-160 Hz

TROUBLESHOOTING HINTS

1. No Character

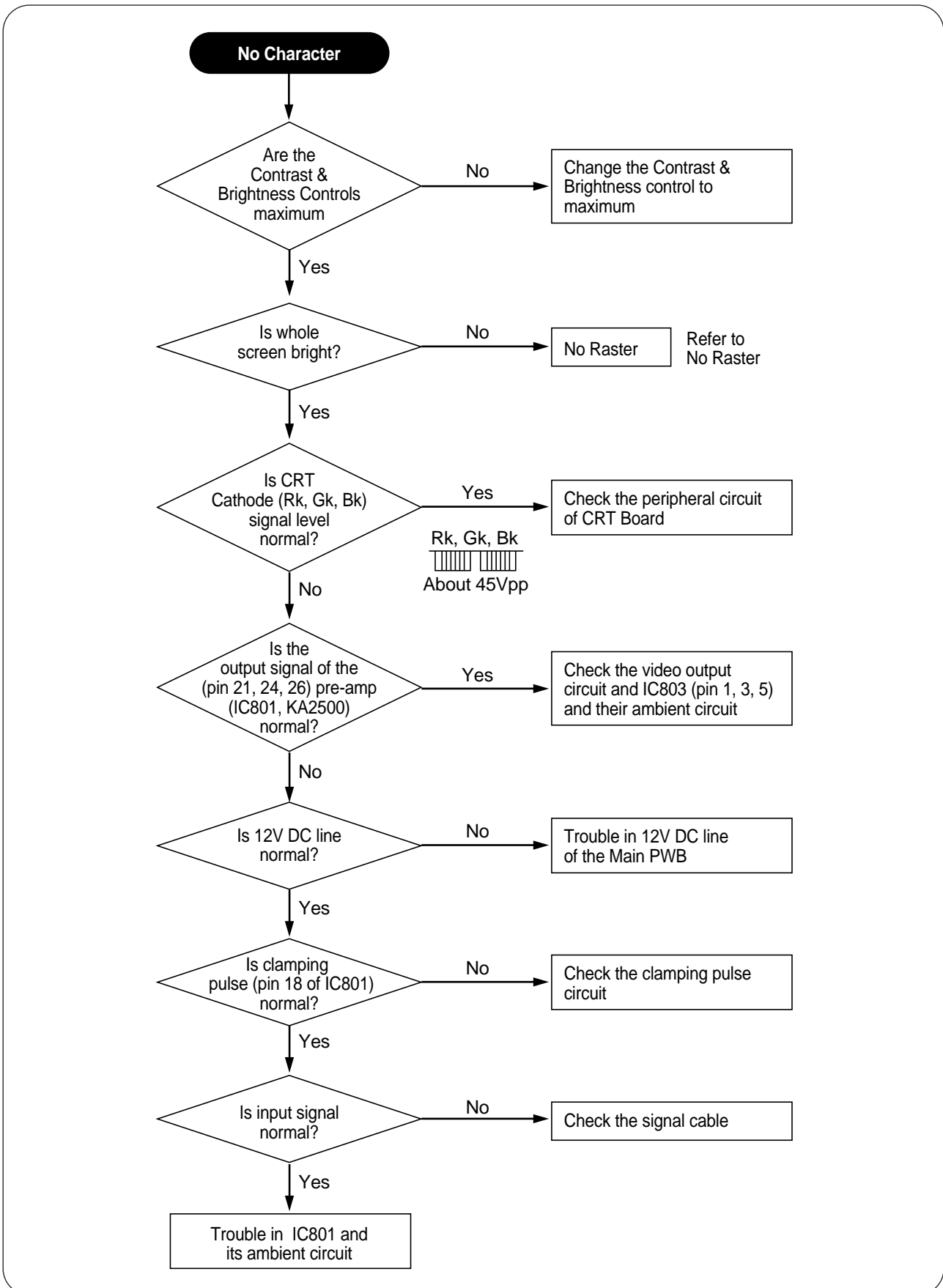

2. No Raster

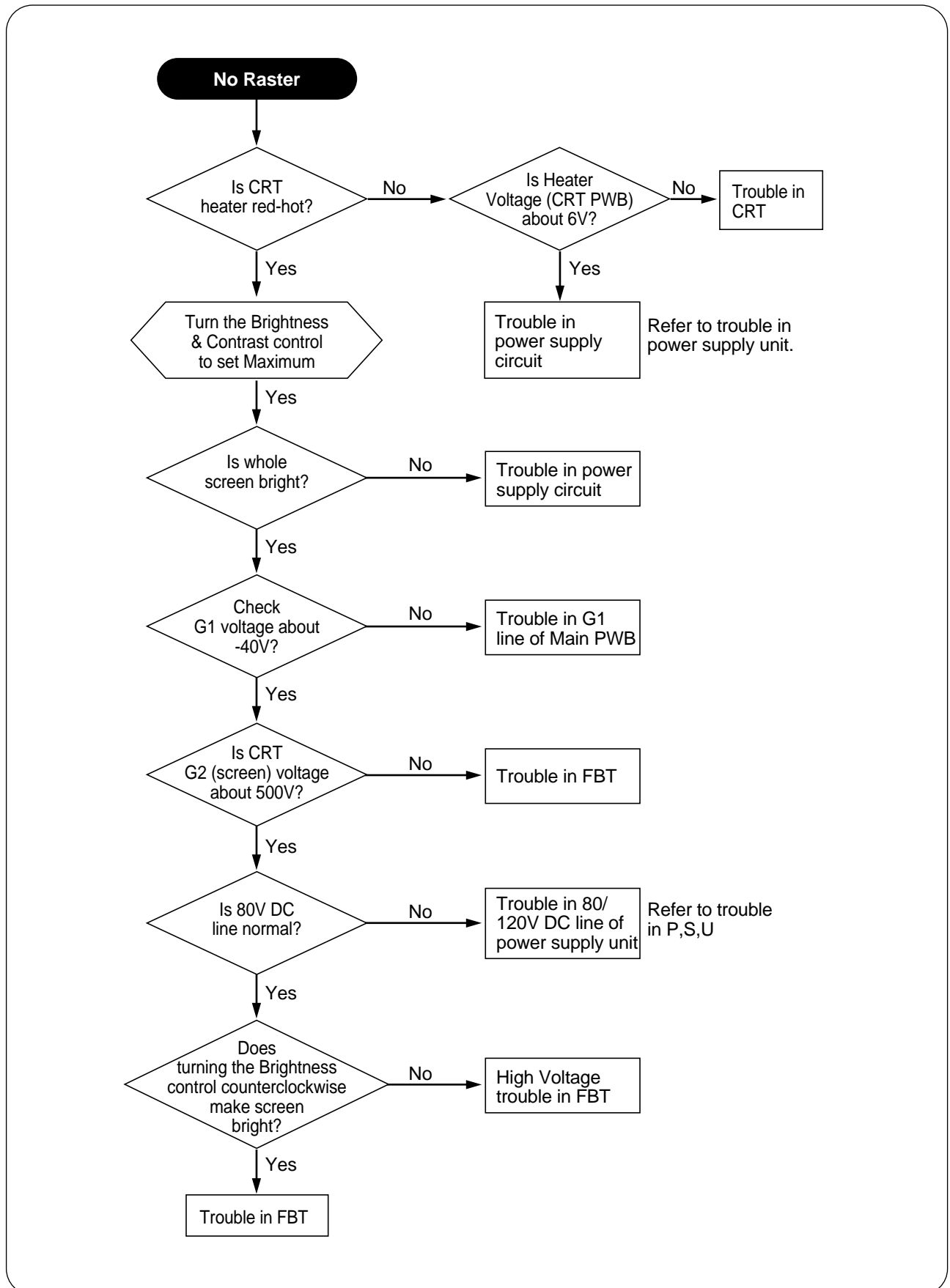

3. A missing Color

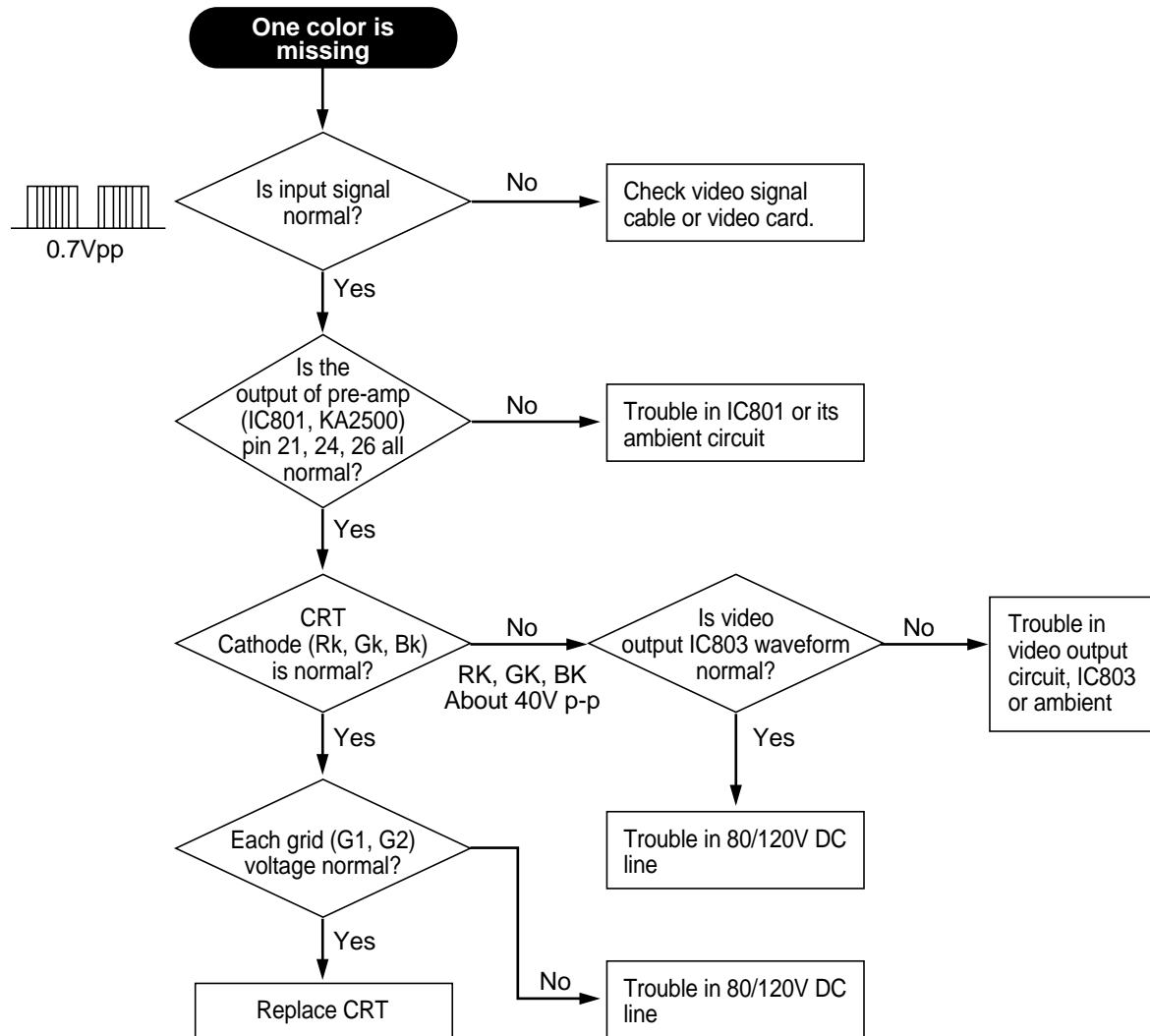

4. Abnormal OSD Font

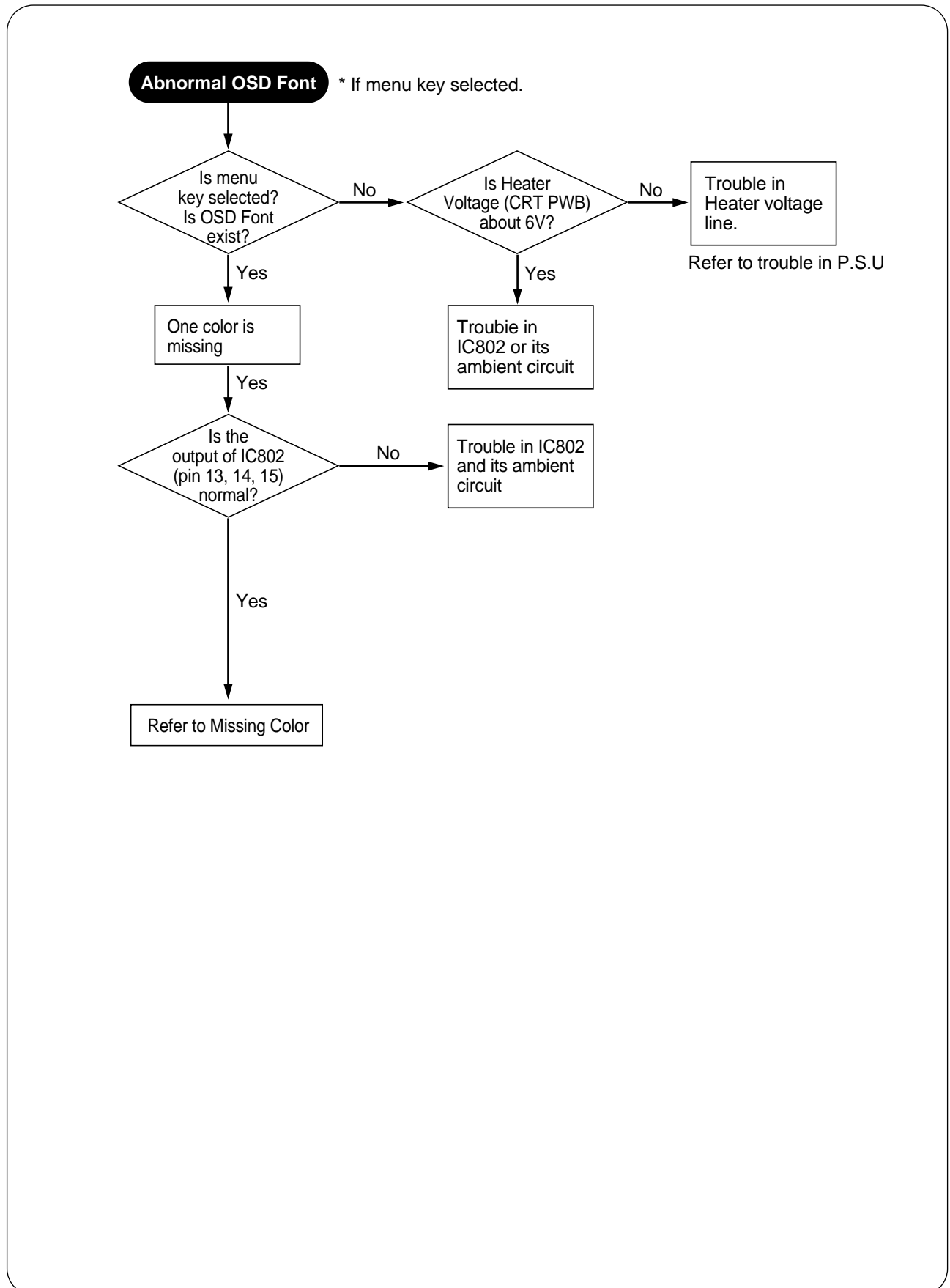

5. Horizontal Output Circuit

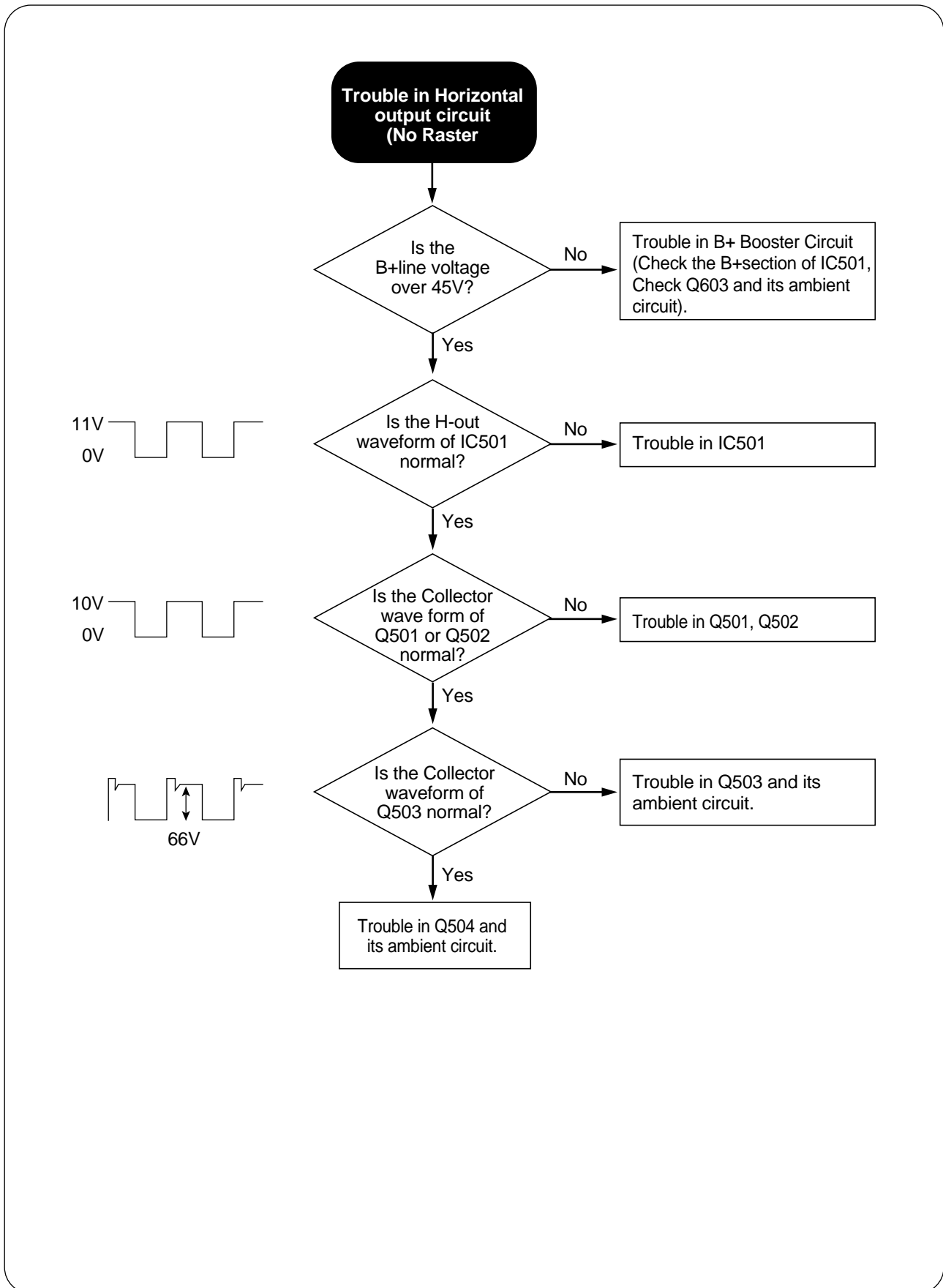

6. Unstable Picture

6-1. Horizontal

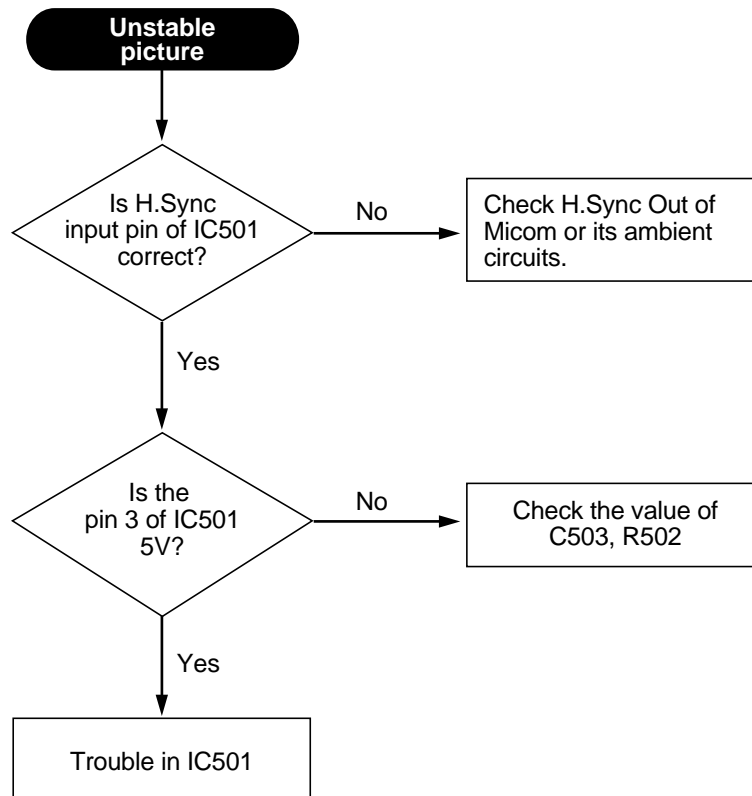

6-2. V.OSC/Deflection Circuit

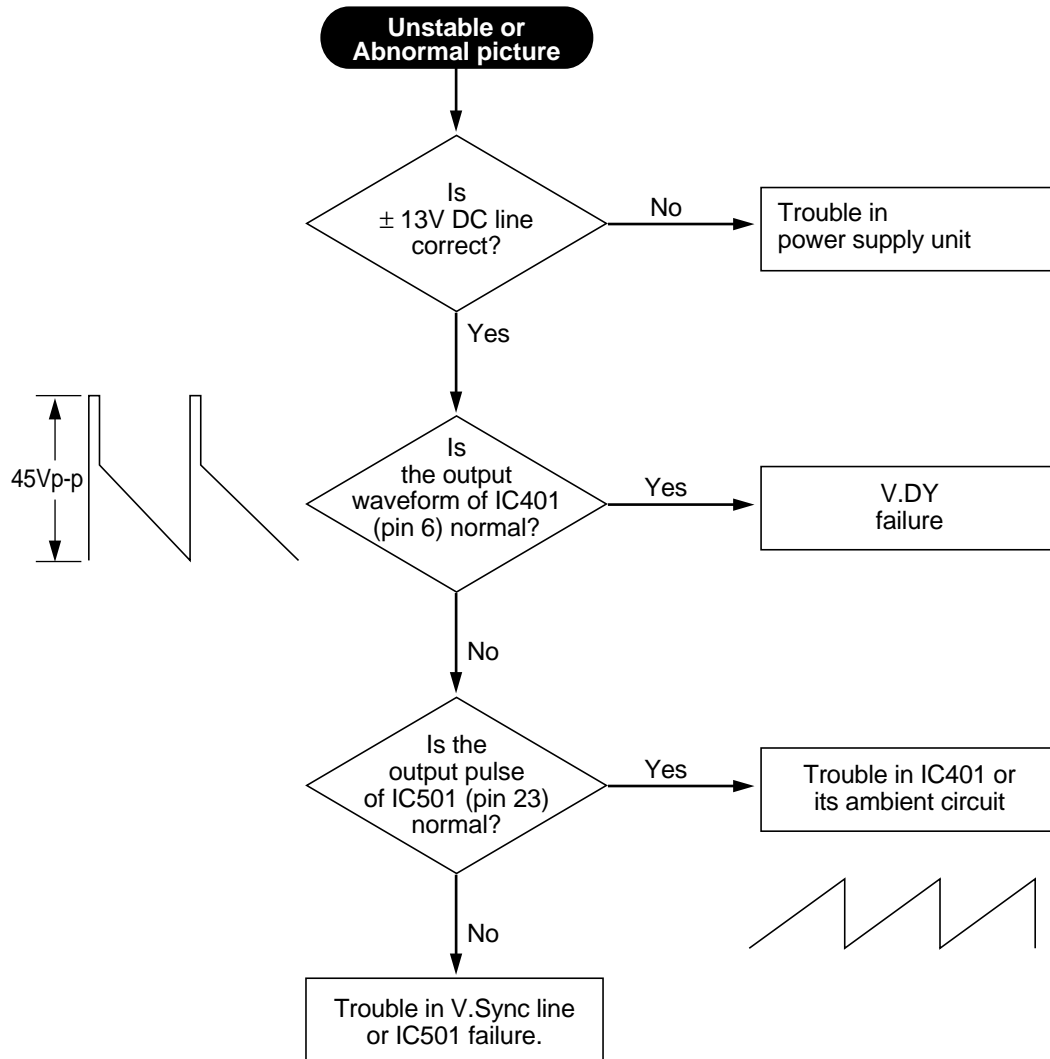

7. Focus

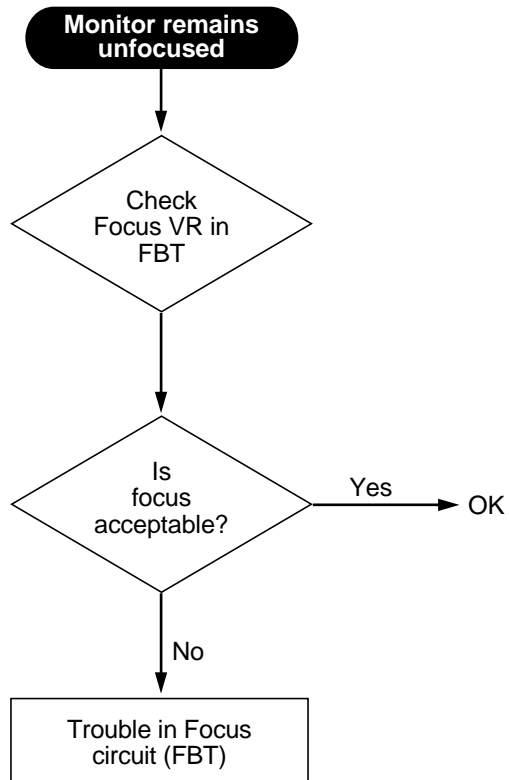

7-1. Dynamic Focus

	F _{VH}	F _{VV}
PHILIPS	: 440V	180V
NEC	: 300V	120V
SAMSUNG	: 300V	120V

Focus is poor

* Check after adjusting the static focus finely by VR in FBT

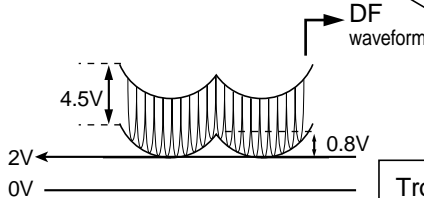
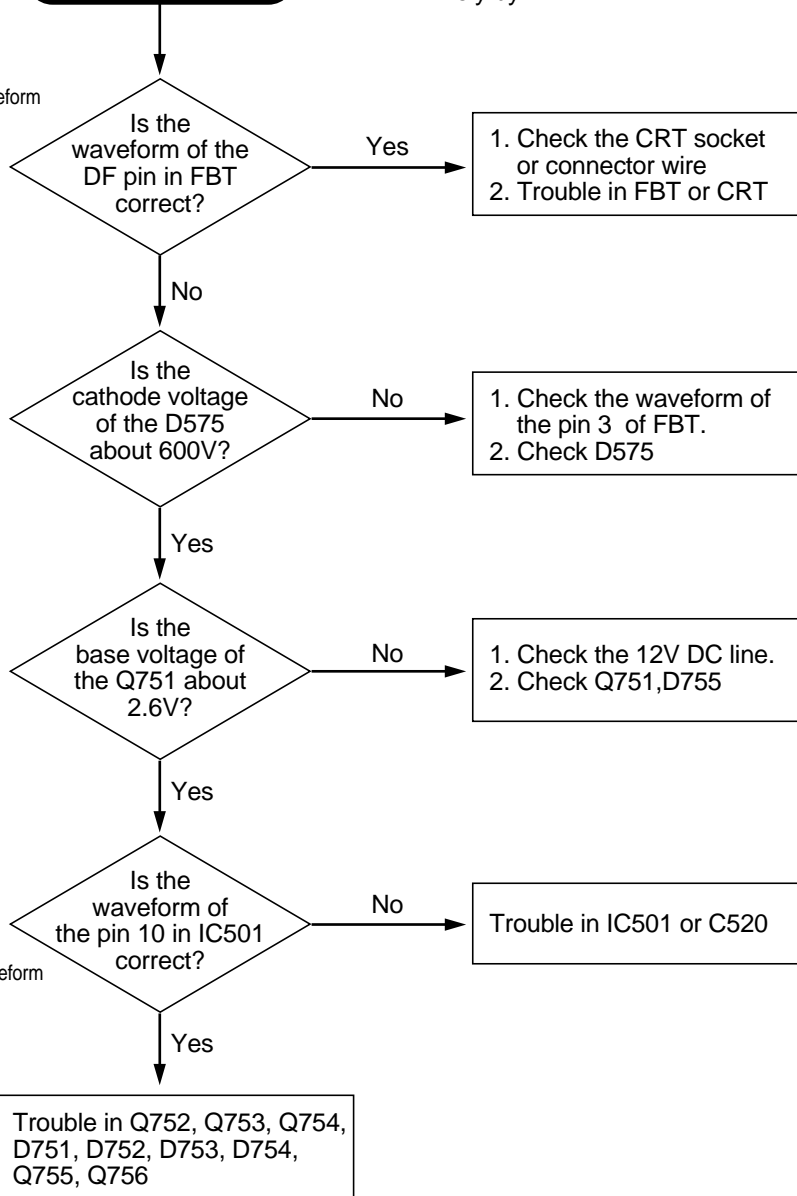
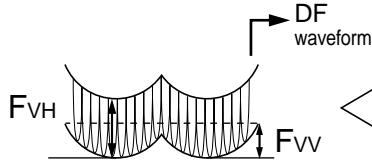

8. Convergence

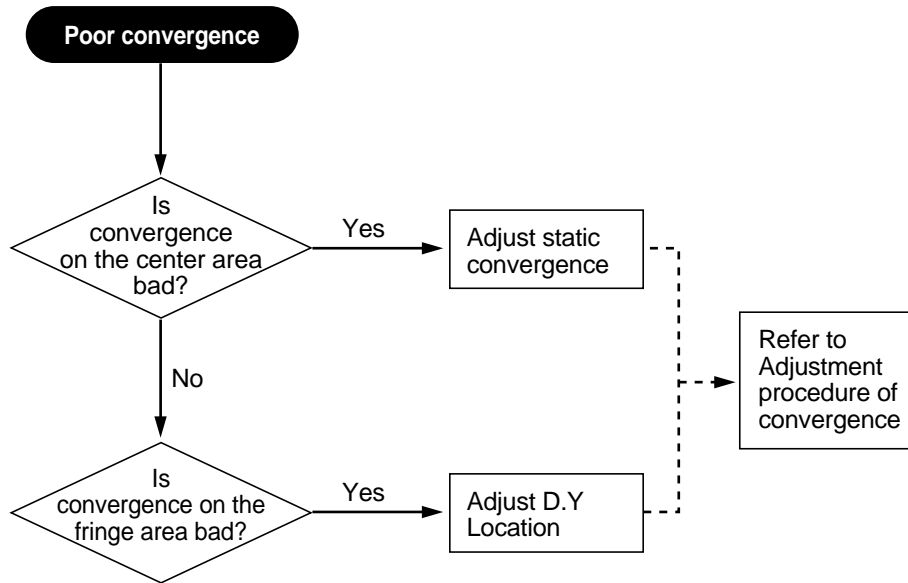

9. Abnormal Picture

9-1. Horizontal Size

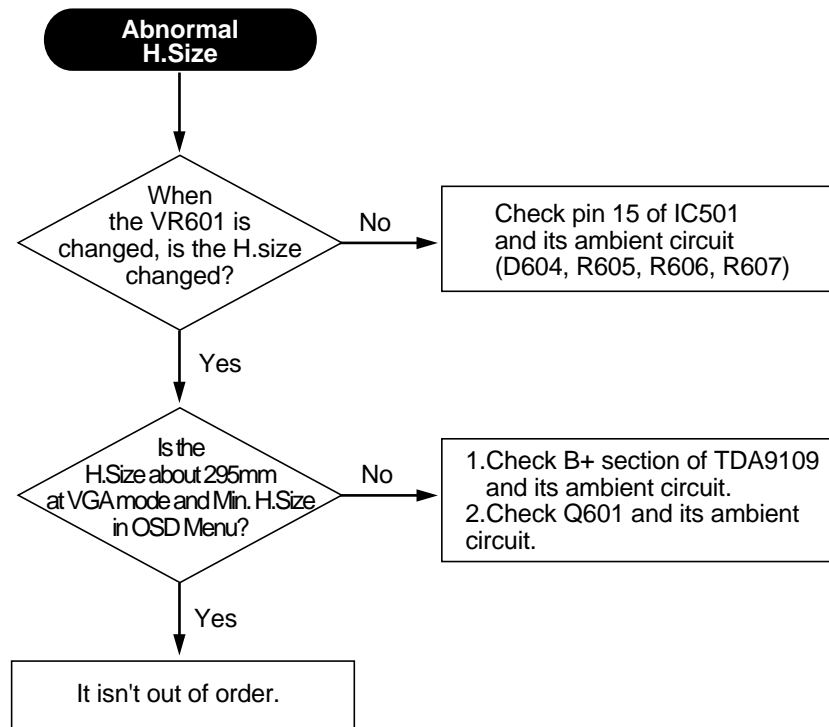

9-2. Vertical Size

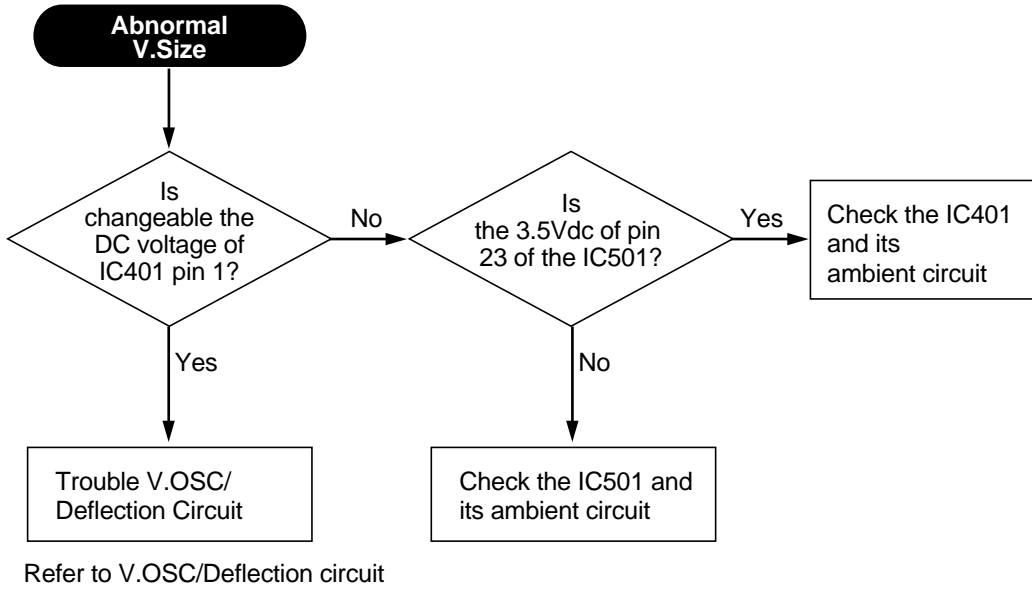

10. High Voltage Circuit

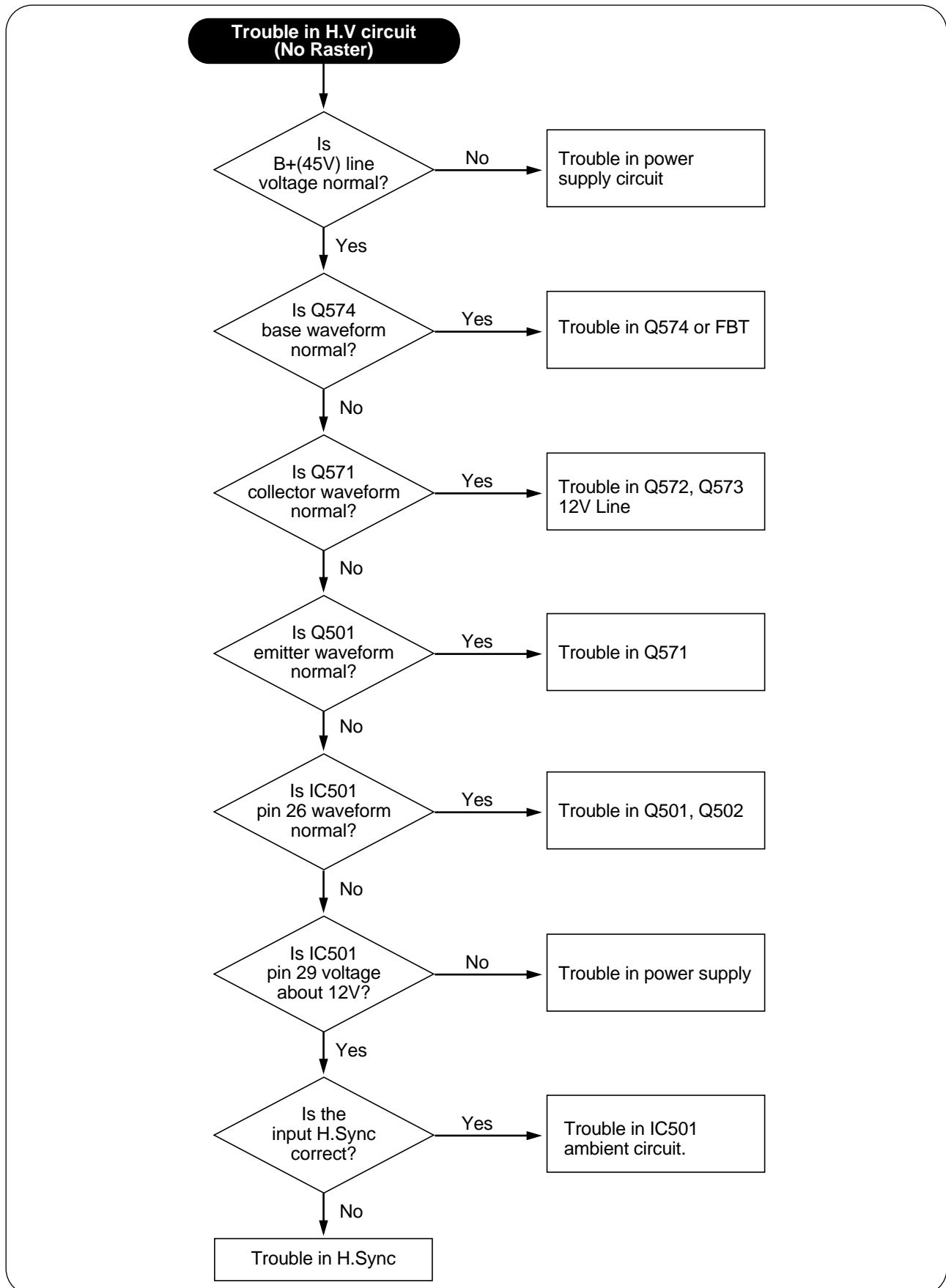

11. Side-Pincushion Circuit

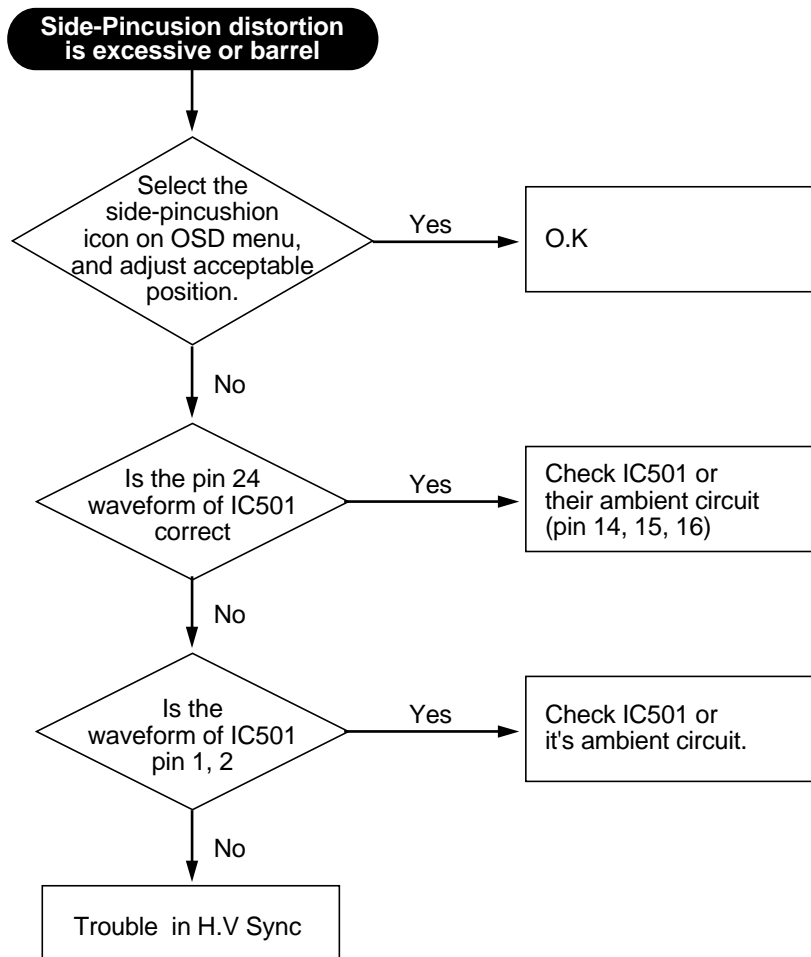

12. Power Supply Unit (P.S.U)

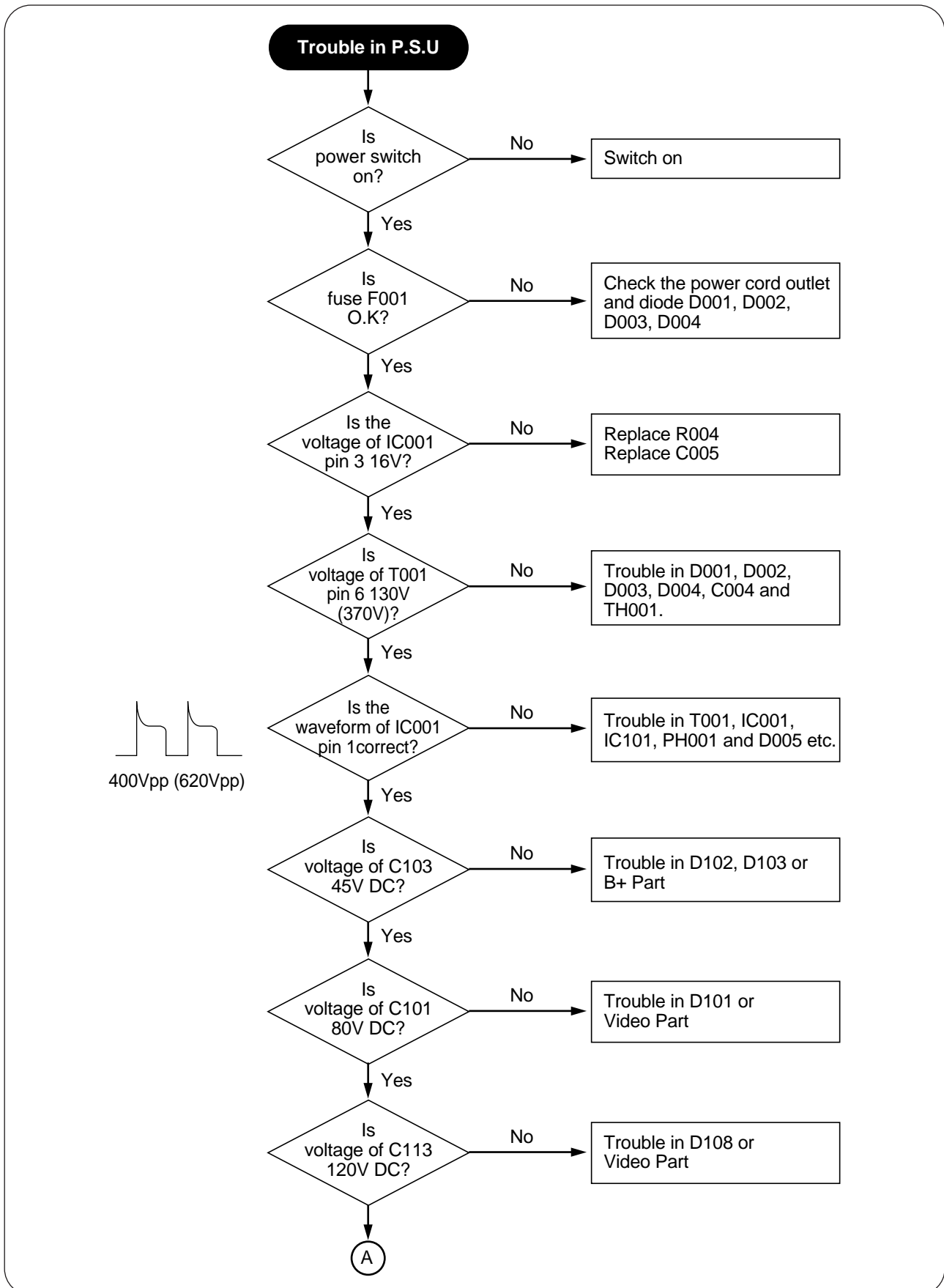

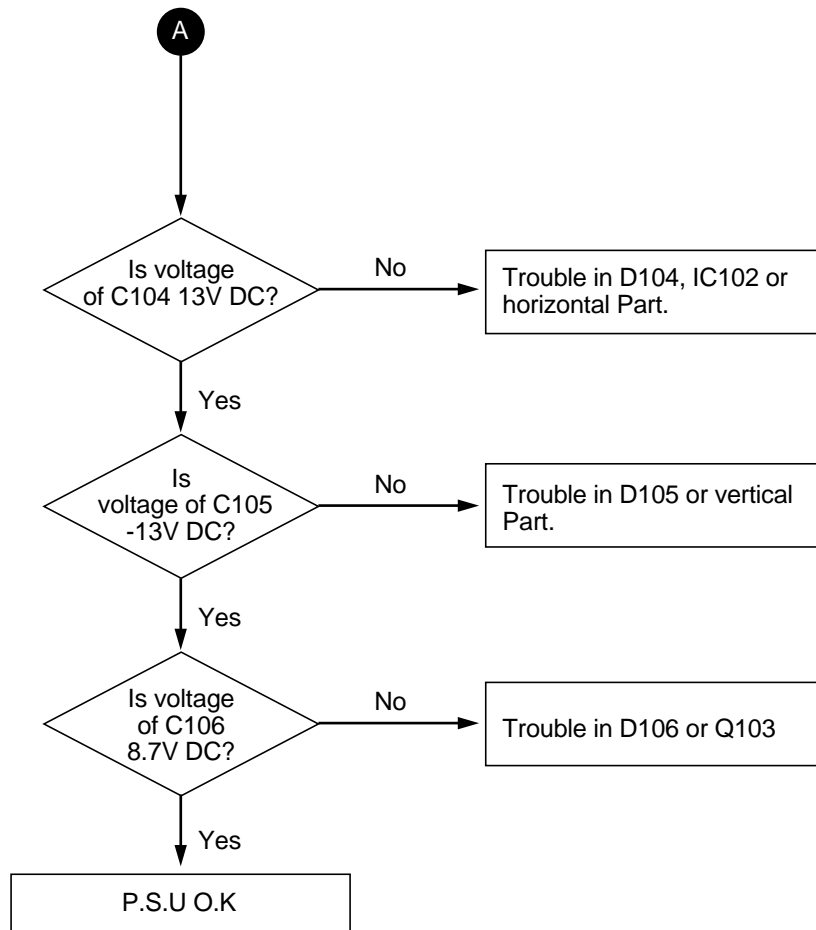

ALIGNMENT PROCEDURE

Standard Adjustment Conditions

1. Power source voltage : AC 120V, 60Hz./AC 220V, 50Hz
2. Aging : Take at least 20 minutes warm-up time.
3. Signals.
 - Video : Analog 0.7Vpp 75 Ω terminal positive polarity
 - Synchronizing : TTL level Negative/Positive Separate/Composite
 - Deflection frequency
 - Horizontal Frequency : 30KHz - 69KHz
 - Vertical Frequency : 50Hz - 160Hz

Pre-Adjustment

1. High voltage Adjustment
 - Adjust 26 kvdc between Anode cap and ground at a cross hatch pattern of 31.5KHz by using VR551.
2. B+ Adjustment (H.min size)
 - (a) Receive a cross hatch pattern of 31.5KHz
 - (b) Set the H-Size control to the minimum.
 - (c) Adjust H-Size to 295mm by using VR601

Main Adjustment

1. Setting the Controls
 - Set the value of items as following.
 - Contrast : Max. (OSD value up to 100)
 - Brightness : Center (Set the OSD value to 50)
2. H.size, V.size, H.phase, V.position, Pincushion, Trapezoid
 - Perceive the cross hatch pattern of Factory preset mode.
 - H.Size, V.size, H.phase, V.position, Pincushion, Trapezoid are adjusted at each mode.
 - In Factory, Auto Alignment was done at each mode. Therefore, Factory preset mode has it's own value according to each control.
3. Focus
 - (a) Set brightness control to center and contrast control to MAX.
 - (b) Receive all "H" character pattern of 60KHz mode signal.
 - (c) Adjust the Focus control of FBT to obtain best Focus (static focus and Dynamic focus).
4. Geometric Distortion Adjustment.
 - (a) Receive the cross hatch pattern of VGA mode signal by using the signal generator.
 - (b) Pin balance, Parallelogram are adjusted the best geometric status.
 - (c) Repeat the adjustment at each mode.
5. White Balance Adjustment
 - (a) Receive a full white pattern of 60KHz mode.
 - (b) Select 9300°K on the OSD Menu.
 - (c) Set the bright control and contrast control to the maximum and receive the all black pattern.
 - (d) Adjust the FBT screen VR to get the screen luminosity to 1 Ft/L.
 - (e) Select the R, G, B Bias on the OSD menu and adjust the ADJUST +/- key to get the color coordinates in X=0.281, Y=0.311
 - (f) If the screen luminosity is changed adjust the sub brightness control to get the 1 Ft/L screen luminosity.
 - (g) Set the brightness control to the center and contrast control to the maximum.
 - (h) Receive a full white pattern.
 - (i) Select the R, G, B gain on the OSD menu and adjust the ADJUST +/- key to get the color coordinates in X=0.281 \pm 0.03, Y=0.311 \pm 0.03
 - (j) Adjust the sub contrast control to get the screen luminosity to 34 Ft/L/
 - (k) Select 6550°K on the OSD menu and set the bright control and contrast control to the maximum and receive the all black pattern.

(l) Repeat (e),(f),(g),(h),(i),(j).

Just a difference from 9300°K mode is color coordinates.

Set color coordinates in $X=0.313$, $Y=0.329$

6. Static Convergence Adjustment

(a) Apply an magenta cross hatch pattern on display.

(b) Adjust the focus from the best over all focus on the display.

Also adjust the brightness to the desired condition.

(c) Vertical red and blue lines are converged by varying the angle between the two tabs of the 4-pole magnets.

(d) Horizontal red and blue lines are converged by varying the tabs together, keeping the angle between them constant.

(e) Apply a white cross hatch pattern on display.

(f) Vertical green and magenta lines are converged by varying the the angle between the two tabs of the 6-pole magnets.

(g) Horizontal green and magenta lines are converged by varying the tabs together, keeping the angle between them constant.

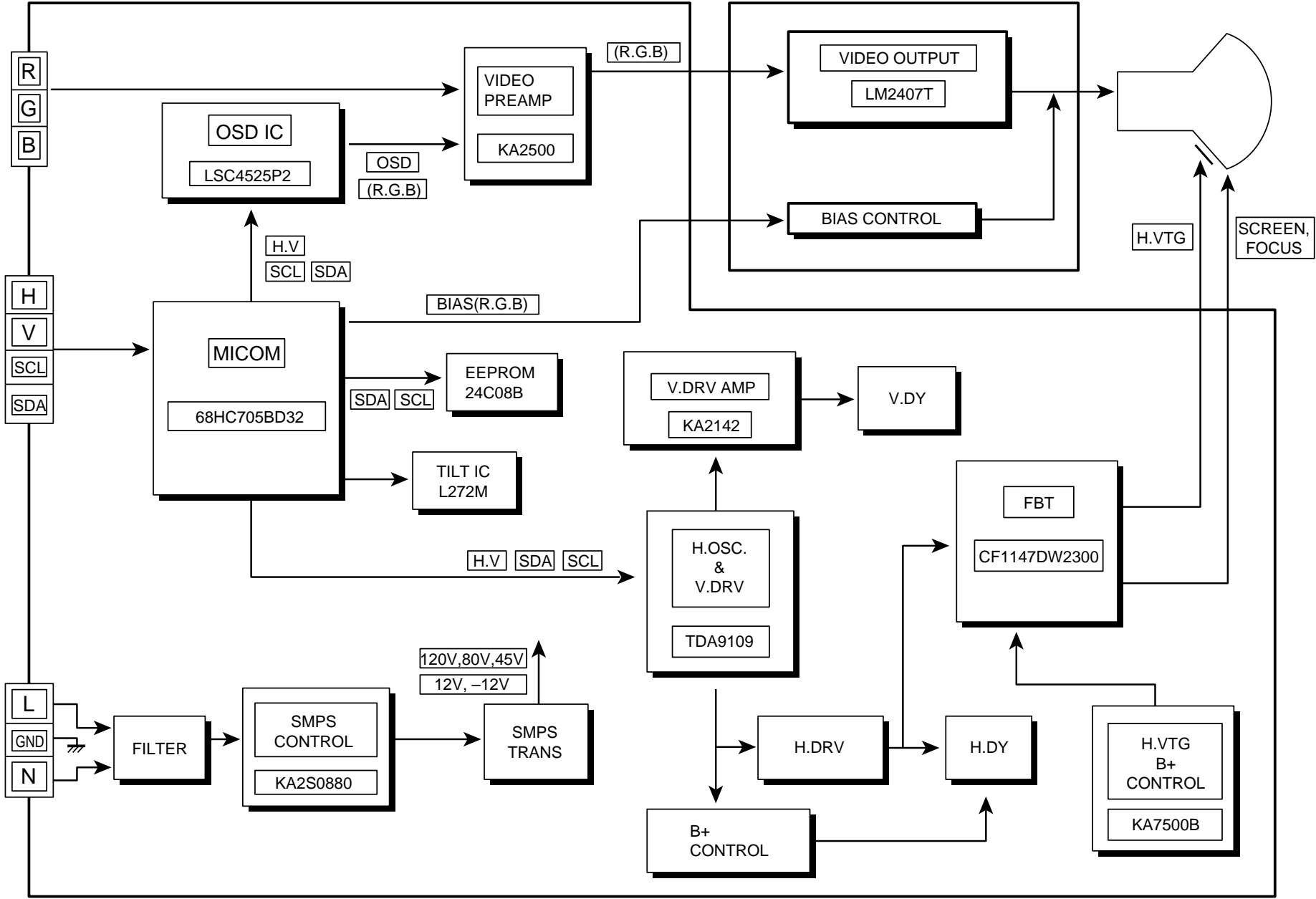

PCB LAYOUT

Main PCB Component Side

Main PCB Solder Side

Video PCB Component Side

Video PCB Solder Side

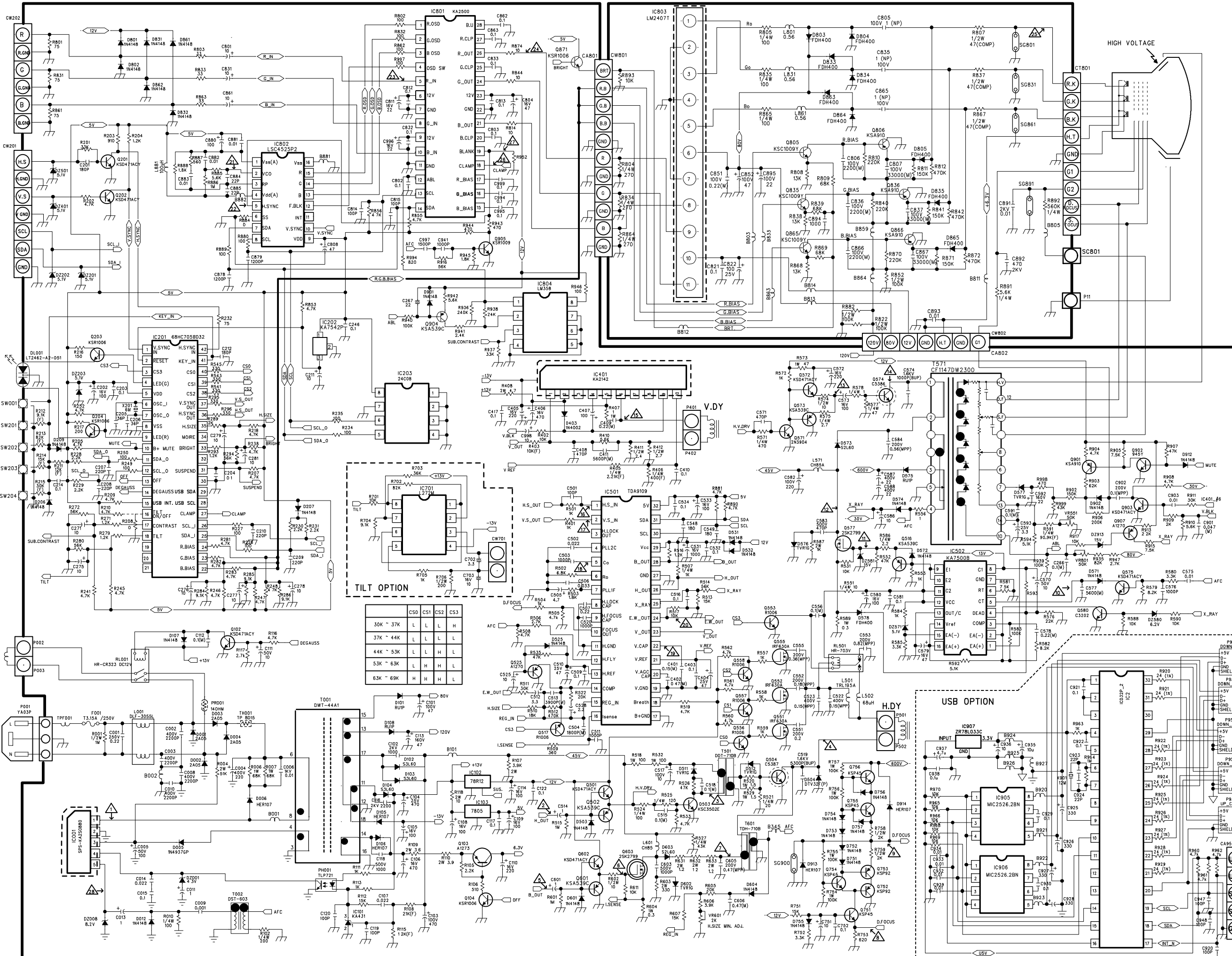

TEST CONDITION
 1. V_{in} : 220V AC
 2. MODE : 69KHz
 3. PTN : F/WHITE

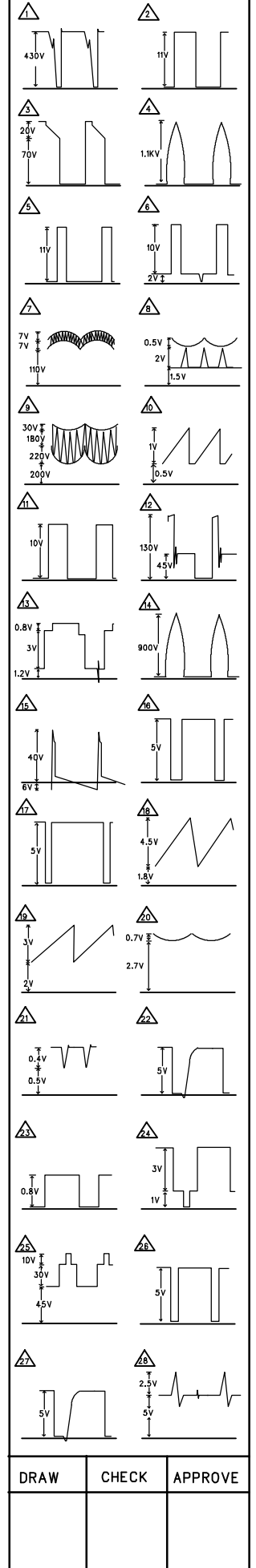

NOTE 1. RESISTANCE IS SHOWN IN OHM, K=1,000, M=1,000,000. (DEFAULT RATING IS 1/6W)
 2. UNLESS OTHERWISE NOTED IN SCHEMATIC ALL CAPACITOR VALUES LESS THAN 1 ARE EXPRESSED IN PF AND THE VALUES 4-VOLTAGES READ WITH "VTVM" FROM POINT INDICATED MORE THAN 1 IN pF (DEFAULT VOLTAGE RATING IS 50V)

3. UNLESS OTHERWISE NOTED IN SCHEMATIC ALL INDUCTOR VALUES MORE THAN 1 ARE EXPRESSED IN uH AND THE VALUES LESS THAN 1 IN H
 4. VOLTAGES READ WITH "VTVM" FROM POINT INDICATED TO CHASSIS GROUND. USING A COLOR BAR SIGNAL WITH ALL CONTROLS AT NORMAL LINE VOLTAGE 120V AC. "WARNING" 5. VOLTAGE READINGS SHOWN ARE NORMAL VALUES AND MAY VARY EXCEPT H.V.
 6. THIS CIRCUIT DIAGRAM IS A STANDARD ONE CIRCUITS PRINTED MAY BE SUBJECT TO CHANGE FOR PRODUCT IMPROVEMENT WITHOUT PRIOR NOTICE.

BEFORE SERVICING THIS CHASSIS READ THE "X-RAY RADIATION PRECAUTION," "SAFETY PRECAUTION" AND "PRODUCT SAFETY NOTICE" IN THE SERVICE MANUAL. CAUTION TO THE SERVICE TECHNICIANS: BEFORE RETURNING THE RECEIVER TO THE CUSTOMER

"CAUTION" THE SHADED AREAS IN THE SCHEMATIC DIAGRAM DESIGNATE COMPONENTS WHICH HAVE SPECIAL CHARACTERISTICS IMPORTANT FOR SAFETY AND SHOULD BE REPLACED ONLY WITH TYPES IDENTICAL TO THOSE IN THE ORIGINAL CIRCUIT OR SPECIFIED IN THE PARTS LIST. DO NOT DEGRADE THE SAFETY OF THE RECEIVER THROUGH IMPROPER SERVICING.

	CS0	CS1	CS2	CS3
30K ~ 37K	L	L	L	L
37K ~ 44K	L	L	L	L
44K ~ 53K	L	L	L	L
53K ~ 63K	L	H	H	L
63K ~ 69K	H	H	H	L

DRAW CHECK APPROVE

CMC-710B

EXPLODED VIEW DIAGRAM

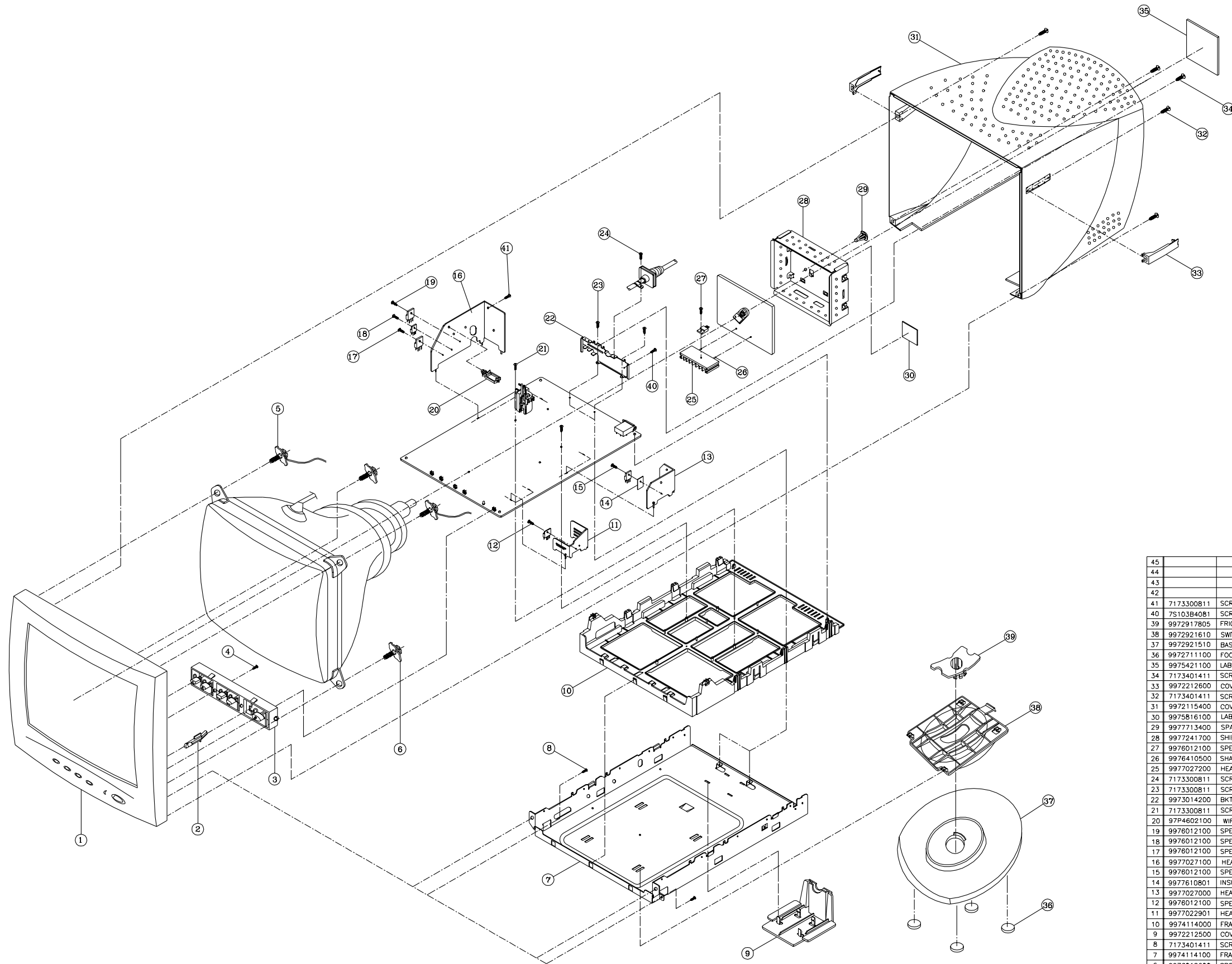

45					
44					
43					
42					
41	7173300811	SCREW TAPTITE	1 TT2 BIN 3x8 MFZN	H/S 271 + GND	
40	75103B4081	SCREW SPECIAL	1 M/C BIN 4x8 MFZN	+BKT REAR(1st GND)	
39	9972917805	FRICION PAD	1 ABS+PC ALLOY GY-275A (94HB)		
38	9972921610	SWIVEL TABLE	1 HIPS GY-275A (94-HB)		
37	9972921510	BASE STAND	1 HIPS GY-275A (94-HB)		
36	9972711100	FOOT	4 RUBBER WHITE 14		
35	9975421100	LABEL RATING	1 P.E T=0.1x98x78mm	+REAR	
34	7173401411	SCREW TAPTITE	1 TT2 BIN 4x14 MFZN	BKT REAR+REAR	
33	9972212600	COVER SCREW	2 FR-ABS GY-275A (94V-0)	+REAR (L/R)	
32	7173401411	SCREW TAPTITE	4 TT2 BIN 4x14 MFZN	FRONT+REAR	
31	9972115400	COVER REAR	1 FR-ABS GY-275A (94V-0)		
30	9975816100	LABEL DHHS	1 ART PAPER 50x40	+SHLD CASE	
29	9977713400	SPACER CARD	1 NYLON 66 (DASC-6N)	+SHLD CASE	
28	9977241700	SHIELD CASE	1 SPTH-C T=0.3		
27	9976012100	SPECIAL SCREW	1 TT2 BIN 3x10 MFZN	H/S 272+IC803	
26	9976410500	SHAFT	2 SWRM SN PLATED	+H/S 272	
25	9977027200	HEAT SINK 272	1 A1050P-H24 H=30	IC803	
24	7173300811	SCREW TAPTITE	1 TT2 BIN 3x8 MFZN	SIGNAL GND+BKT REAR	
23	7173300811	SCREW TAPTITE	2 TT2 BIN 3x8 MFZN	BKT REAR+FRM BTM	
22	9973014200	BKT REAR	1 EGI T=1.0		
21	7173300811	SCREW TAPTITE	2 TT2 BIN 3x8 MFZN	PCB+FRM PCB	
20	97P4602100	WIRE SADDLE	1 NYLON 66(DASW-3N)	+H/S 271	
19	9976012100	SPECIAL SCREW	1 TT2 BIN 3x10 MFZN	H/S 271+0574	
18	9976012100	SPECIAL SCREW	1 TT2 BIN 3x10 MFZN	H/S 271+0504	
17	9976012100	SPECIAL SCREW	1 TT2 BIN 3x10 MFZN	H/S 271+0504	
16	9977027100	HEAT SINK 271	1 A1050P-H24 T=2.0	0504.D504.D574	
15	9976012100	SPECIAL SCREW	1 TT2 BIN 3x10 MFZN	H/S 270+IC001	
14	9977610801	INSULATOR	1 SILICON RUBBER T=0.3x28.5x25	+H/S 270	
13	9977027000	HEAT SINK 270	1 A1050P-H24 T=2.0	IC001	
12	9976012100	SPECIAL SCREW	1 TT2 BIN 3x10 MFZN	H/S 271+IC401	
11	9977022901	HEAT SINK 229	1 A1050P-H24 T=2.0	IC401	
10	9974114000	FRAME PCB	1 FR-ABS GY-275A (94V-0)		
9	9972212500	COVER SIGNAL	1 FR-ABS GY-275A (94V-0)		
8	7173401411	SCREW TAPTITE	2 TT2 BIN 4x14 MFZN	FRONT+FRM BTM	
7	9974114100	FRAME BOTTOM	1 EGI T=1.0		
6	9976012600	SPECIAL SCREW 5	2 TT2 HEX 5x21 MFZN SP	FRONT+CRT	
5	9976013000	SPECIAL SCREW	2 TT2 HEX 5x21 SCREW+B	FRONT+CRT	
4	7173301011	SCREW TAPTITE	1 TT2 BIN 3x10 MFZN	FRONT+BUTTON TACT	
3	9974820400	BUTTON TACT	1 FR-ABS GY-275A (94V-0)		
2	9977916200	LENS LED	1 ACRYL (CLEAR)		
1	9972018600	COVER FRONT	1 FR-ABS GY-275A (94V-0)		
NO	PART CODE	PART NAME	QTY	DESCRIPTION	REMARK

REPLACEMENT PARTS LIST

Important Safety Notice

Components identified with the International Symbol have special characteristics important for safety. When replacing any components, use only manufacturer's specified parts.

Abbreviation of Description

RESISTOR Description

Allowance	
F	± 1%
J	± 5%
K	± 10%
M	± 20%
G	± 2%

Example:

Fig & Index	Part No	Description
R101	Resistors	
	RE-42820J	Cabron: 82J

CAPACITOR Description

Allowance	
C	± 0.25pF
D	± 0.5%
F	± 1pF
J	± 5%
K	± 10%
P	± 100% ~ 0%
Z	± 80% ~ -

Example:

Fig & Index	Part No	Description
C102	Capacitors	
	CCXF1H104Z	Ceramic 50V Z
	CBSLH200J	Ceramic 50V J
C402	CCXB1H331K	Ceramic 50V K

CIRCUIT BOARD ELECTRICAL PARTS LIST

The components identified by mark  have special characteristics important for safety and x-ray radiation. These should be replaced only with the types specified in the parts list.

LOC	PART-CODE	PART-NAME	PART-DESC	
	10010	PCFMCAJ046	COVER FRONT AS	CMC-710B
	CT801	9979617018	CDT	M41QAR361X124(E)
	CT802	9970710176	CRT GND AS	0.12*5*24+BL102NG=730
	DG001	5MG0000062	COIL DEGAUSSING	DG-710B
	20010	PCMPM1J046	PCB MAIN MANUAL AS	CMC-710B
	CA801	99707A0016	CONN AS	SMH250-10+1007#24#28=160
	CA802	9970770019	CONN AS	SMH250-07+1007#24=220
	CN001	9970700123	CONN AS	4.3+35404-9002+1015#18=50
	C001	CL1UC3224M	C LINE ACROSS	0.22MF 1J(UCVSNDF/SV)+Q/O
	C004	CEYP2G221Z	C ELECTRO	400V SMH 220MF (25.4*40)
	C006	CCYB3A103K	C CERA	1KV B 0.01MF K
	C103	CEXF2A471V	C ELECTRO	100V RSS 470MF 16*31.5
	C402	CMXL2A474J	C MYLAR	MEU 100V 0.47MF J
	C406	CEXF1C471V	C ELECTRO	16V RSS 470MF (10X12.5)TP
	C409	CMXM2A224J	C MYLAR	100V 0.22MF J
	C519	CMYH3D532J	C MYLAR	2KV BUP 5300PF J BULK
	C553	CMXF2D824J	C MYLAR	MPP 200V 0.82MF J
	C578	CMXM2A224J	C MYLAR	100V 0.22MF J
	DL001	DLT2462A2D	LED	LT2462-A2-D51
	D102	DS3L60----	DIODE	S3L60
	D103	DS3L60----	DIODE	S3L60
	D104	DS3L60----	DIODE	S3L60
	F001	5F3CB3122L	FUSE CERA	SEMKO TL 3.15A 250V MF51
	IC001	1KA2S0880-	IC POWER	KA2S0880
	IC102	1KA78R12--	IC REGULATOR	KA78R12
	IC103	1K1A7805P1	IC REGULATOR	KIA7805PI
	IC201	1DWM209T--	IC MICOM	68HC705BD32
	IC401	1KA2142---	IC V-OUT	KA2142
	IC501	1TDA9109--	IC H.OSC	TDA9109
	IC801	1KA2500---	IC	KA2500
	L001	5PDLF3055-	FILTER LINE	DLF-3055L
	L501	5MH0000051	COIL H-LINEARITY	TRL-195A
	L502	5MC0000069	COIL CHOKE	33UH K BULK(14*16)
	L571	5MC0000068	COIL CHOKE	CH-85A
	L601	5MC0000065	COIL CHOKE	CH-85
	PH001	1TLP721GR-	IC PHOTO COUPLER	TLP721D4GR
	P001	9979500014	RECEPTACLE	YA03P/FILTER EMI
	Q503	TKSC3502E-	TR	KSC3502E

LOC	PART-CODE	PART-NAME	PART-DESC
D504	DDTV32F---	DIODE	DTV32F
Q504	T2SC5387--	TR H.OUT	2SC5387
Q574	TKSC5386--	TR	KSC5386
Q551	T1RF630ATS	FET	IRF630A-TSTU
Q552	T1RF630ATS	FET	IRF630A-TSTU
Q555	T1RF630ATS	FET	IRF630A-TSTU
Q577	T2SK2799--	FET	2SK2799
Q603	T2SK2799--	FET	2SK2799
⚠	RL001	5SC0201103	SW RELAY
	RL501	5SC0101031	SW RELAY
	R754	RS01Z104J-	R M-OXIDE FILM
	SG900	4SG0D00104	SPARK GAP
	SW001	5S50101Z01	SW TACT
	S001	9970800015	CABLE SIGNAL AS
⚠	TH001	DTP8D15---	THERMISTOR
⚠	T001	5RM0000090	TRANS SMPS
	T002	5RY0000002	TRANS SYNC
	T501	5RD0000037	TRANS DRIVE
	T571	5RH0000105	FBT
	T601	5RF0000003	TRANS DUMMY
	30010	PCMPJ1J046	PCB SMD AS
	C015	HCFK104ZCA	C CHIP CERA
	C117	HCFK104ZCA	C CHIP CERA
	C119	HCQK101JCA	C CHIP CERA
	C120	HCQK101JCA	C CHIP CERA
	C122	HCFK104ZCA	C CHIP CERA
	C203	HCFK104ZCA	C CHIP CERA
	C204	HCFK104ZCA	C CHIP CERA
	C205	HCQK360JCA	C CHIP CERA
	C206	HCQK360JCA	C CHIP CERA
	C212	HCQK181JCA	C CHIP CERA
	C403	HCFK104ZCA	C CHIP CERA
	C502	HCBK223KCA	C CHIP CERA
	C503	HCQK102JCA	C CHIP CERA
	C506	HCFK333ZCA	C CHIP CERA
	C507	HCFK224ZCA	C CHIP CERA
	C520	HCQK102JCA	C CHIP CERA
	C532	HCFK104ZCA	C CHIP CERA
	C549	HCQK181JCA	C CHIP CERA
	C581	HCFK104ZCA	C CHIP CERA

LOC	PART-CODE	PART-NAME	PART-DESC
C802	HCFK104ZCA	C CHIP CERA	50V Y5V 0.1MF Z 2012
C803	HCFK104ZCA	C CHIP CERA	50V Y5V 0.1MF Z 2012
C812	HCFK104ZCA	C CHIP CERA	50V Y5V 0.1MF Z 2012
C813	HCFK104ZCA	C CHIP CERA	50V Y5V 0.1MF Z 2012
C814	HCQK101JCA	C CHIP CERA	50V CH 100PF J 2012
C815	HCQK101JCA	C CHIP CERA	50V CH 100PF J 2012
C832	HCFK104ZCA	C CHIP CERA	50V Y5V 0.1MF Z 2012
C833	HCFK104ZCA	C CHIP CERA	50V Y5V 0.1MF Z 2012
C862	HCFK104ZCA	C CHIP CERA	50V Y5V 0.1MF Z 2012
C863	HCFK104ZCA	C CHIP CERA	50V Y5V 0.1MF Z 2012
C878	HCQK122JCA	C CHIP CERA	50V CH 1200PF J 2012
C879	HCQK122JCA	C CHIP CERA	50V CH 1200PF J 2012
C881	HCFK103ZCA	C CHIP CERA	50V Y5V 0.01MF Z 2012
C882	HCFK103ZCA	C CHIP CERA	50V Y5V 0.01MF Z 2012
C883	HCFK103ZCA	C CHIP CERA	50V Y5V 0.01MF Z 2012
C884	HCQK220JCA	C CHIP CERA	50V CH 22PF J 2012
C885	HCQK220JCA	C CHIP CERA	50V CH 22PF J 2012
R117	HRFT272JCA	R CHIP	1/10 2.7K OHM J 2012
R205	HRFT472JCA	R CHIP	1/10 4.7K OHM J 2012
R208	HRFT000JCA	R CHIP	1/10 0 OHM J 2012
R209	HRFT472JCA	R CHIP	1/10 4.7K OHM J 2012
R210	HRFT472JCA	R CHIP	1/10 4.7K OHM J 2012
R216	HRFT151JCA	R CHIP	1/10 150 OHM J 2012
R217	HRFT201JCA	R CHIP	1/10 200 OHM J 2012
R218	HRFT472JCA	R CHIP	1/10 4.7K OHM J 2012
R228	HRFT222JCA	R CHIP	1/10 2.2K OHM J 2012
R234	HRFT101JCA	R CHIP	1/10 100 OHM J 2012
R235	HRFT101JCA	R CHIP	1/10 100 OHM J 2012
R238	HRFT472JCA	R CHIP	1/10 4.7K OHM J 2012
R246	HRFT472JCA	R CHIP	1/10 4.7K OHM J 2012
R247	HRFT472JCA	R CHIP	1/10 4.7K OHM J 2012
R248	HRFT472JCA	R CHIP	1/10 4.7K OHM J 2012
R252	HRFT472JCA	R CHIP	1/10 4.7K OHM J 2012
R272	HRFT563JCA	R CHIP	1/10 56K OHM J 2012
R284	HRFT912JCA	R CHIP	1/10 9.1K OHM J 2012
R285	HRFT912JCA	R CHIP	1/10 9.1K OHM J 2012
R286	HRFT912JCA	R CHIP	1/10 9.1K OHM J 2012
R289	HRFT202JCA	R CHIP	1/10 2K OHM J 2012
R502	HRFT682JCA	R CHIP	1/10 6.8K OHM J 2012
R505	HRFT472JCA	R CHIP	1/10 4.7K OHM J 2012

LOC	PART-CODE	PART-NAME	PART-DESC
R506	HRFT272JCA	R CHIP	1/10 2.7K OHM J 2012
R508	HRFT472JCA	R CHIP	1/10 4.7K OHM J 2012
R513	HRFT153JCA	R CHIP	1/10 15K OHM J 2012
R515	HRFT105JCA	R CHIP	1/10 1M OHM J 2012
R516	HRFT122JCA	R CHIP	1/10 1.2K OHM J 2012
R517	HRFT103JCA	R CHIP	1/10 10K OHM J 2012
R531	HRFT103JCA	R CHIP	1/10 10K OHM J 2012
R576	HRFT223JCA	R CHIP	1/10 22K OHM J 2012
R581	HRFT752JCA	R CHIP	1/10 7.5K OHM J 2012
R753	HRFT621JCA	R CHIP	1/10 620 OHM J 2012
R801	HRFT750JCA	R CHIP	1/10 75 OHM J 2012
R831	HRFT750JCA	R CHIP	1/10 75 OHM J 2012
R853	HRFT472JCA	R CHIP	1/10 4.7K OHM J 2012
R856	HRFT472JCA	R CHIP	1/10 4.7K OHM J 2012
R861	HRFT750JCA	R CHIP	1/10 75 OHM J 2012
R880	HRFT101JCA	R CHIP	1/10 100 OHM J 2012
R885	HRFT562JCA	R CHIP	1/10 5.6K OHM J 2012
R886	HRFT105JCA	R CHIP	1/10 1M OHM J 2012
R887	HRFT561JCA	R CHIP	1/10 560 OHM J 2012
R888	HRFT182JCA	R CHIP	1/10 1.8K OHM J 2012
R889	HRFT101JCA	R CHIP	1/10 100 OHM J 2012
R890	HRFT472JCA	R CHIP	1/10 4.7K OHM J 2012
R936	HRFT244JCA	R CHIP	1/10 240K OHM J 2012
R938	HRFT243JCA	R CHIP	1/10 24K OHM J 2012
R942	HRFT562JCA	R CHIP	1/10 5.6K OHM J 2012
40010	PCMPJ0J046	PCB MAIN ODD SHAPE AS	CMC-710B
CW201	485923282S	CONN WAFER	5267-07A STICK TYPE
CW202	485923272S	CONN WAFER	5267-06A STICK TYPE
⚠	C002	CH1FDF222M	C CERA AC HIKB AC400V 222M
⚠	C003	CH1FDF222M	C CERA AC HIKB AC400V 222M
⚠	C008	CH1FDF222M	C CERA AC HIKB AC400V 222M
⚠	C010	CH1FDF222M	C CERA AC HIKB AC400V 222M
	C101	CEXF2A470V	C ELECTRO 100V RSS 47MF (10X16) TP
	C102	CCXB3D102K	C CERA 2KV B 1000PF K (TAPPING)
	C104	CEXF1E471V	C ELECTRO 25V RSS 470MF (10X16) TP
	C106	CEXF1C471V	C ELECTRO 16V RSS 470MF (10X12.5)TP
	C113	CEXF2C470V	C ELECTRO 160V RSS 47MF (13X25) TP
	C116	CCXB3D222K	C CERA HIKB 2KV 2200PF K
	C522	CMXF2G184J	C MYLAR MPP 400V 0.18MF J
	C523	CMXF2G154J	C MYLAR MPP 400V 0.15MF J

LOC	PART-CODE	PART-NAME	PART-DESC	
C531	CEXF1C102V	C ELECTRO	16V RSS 1000MF (10X20) TP	
C551	CMXF2D204J	C MYLAR	MPP 200V 0.2MF J (TP)	
C552	CMXF2D184J	C MYLAR	MPP 200V 0.18MF J (TP)	
C555	CMXF2D334J	C MYLAR	200V MPP 0.33MF J (TP)	
C574	CMXH3C102J	C MYLAR	1.6KV BUP 1000PF J	
C582	CEXF2A221V	C ELECTRO	100V RSS 220MF (16X25) TP	
C584	CMXF2D564J	C MYLAR	MPP 200V 0.56MF J	
C587	CEXF2G220D	C ELECTRO	400V KMG 22MF(12.5*25) TP	
C588	CEXF2G220D	C ELECTRO	400V KMG 22MF(12.5*25) TP	
C592	CEXF2C220V	C ELECTRO	160V RSS 22MF (10X20) TP	
C605	CMXF2D474J	C MYLAR	MPP 200V 0.47MF J	
C902	CMXF2D104J	C MYLAR	MPP 200V 0.1MF J	
⚠	D001	D2A05-----	DIODE	2A05
⚠	D002	D2A05-----	DIODE	2A05
⚠	D003	D2A05-----	DIODE	2A05
⚠	D004	D2A05-----	DIODE	2A05
	D005	D1N4937GP-	DIODE	1N4937GP (TAPPING)
	D006	DDHER107---	DIODE	HER107
	D101	DRU1P-----	DIODE	RU 1P (TAPPING)
	D105	DDHER107---	DIODE	HER107
	D106	DDHER107---	DIODE	HER107
	D108	DRU1P-----	DIODE	RU 1P (TAPPING)
	D403	D1N4002A--	DIODE	1N4002
	D511	DTVR1G----	DIODE	TVR1G TPA1
	D512	DTVR1G----	DIODE	TVR1G TPA1
	D573	DS2L60---R	DIODE	S2L60
	D575	DRU1P-----	DIODE	RU 1P (TAPPING)
	D576	DTVR1G----	DIODE	TVR1G TPA1
	D577	DTVR1G----	DIODE	TVR1G TPA1
	D602	DTVR1G----	DIODE	TVR1G TPA1
	D603	DS2L60---R	DIODE	S2L60
	D913	DDHER107---	DIODE	HER107
	D914	DDHER107---	DIODE	HER107
	IC203	1M24C08BN6	IC EEPROM	M24C08BN6
	IC502	1KA7500B--	IC	KA7500B
	IC802	1LSC4525P2	IC OSD	LSC4525P2
	IC804	1LM358N---	IC OP AMP	LM358N
	PR001	DECPAC140M	POSISTOR	ECPAC140M290
	P002	9977410800	TERMINAL PIN	BSP1(SN) L=15MM
	P003	9977410800	TERMINAL PIN	BSP1(SN) L=15MM

LOC	PART-CODE	PART-NAME	PART-DESC
P401	9977410800	TERMINAL PIN	BSP1(SN) L=15MM
P402	9977410800	TERMINAL PIN	BSP1(SN) L=15MM
P403	9977410800	TERMINAL PIN	BSP1(SN) L=15MM
P501	9977410800	TERMINAL PIN	BSP1(SN) L=15MM
P502	9977410800	TERMINAL PIN	BSP1(SN) L=15MM
P503	9977410800	TERMINAL PIN	BSP1(SN) L=15MM
P504	9977410800	TERMINAL PIN	BSP1(SN) L=15MM
R004	RS02Z513J-	R M-OXIDE FILM	2W 51K OHM J
R006	RS01Z683J-	R M-OXIDE FILM	1W 68K OHM J (TAPPING)
R007	RS01Z683J-	R M-OXIDE FILM	1W 68K OHM J (TAPPING)
R107	RS02Z392J-	R M-OXIDE FILM	2W 3.9K OHM J (TAPPING)
R109	RS02Z369J-	R M-OXIDE FILM	2W 3.6 OHM J (TAPPING)
R110	RS02Z399J-	R M-OXIDE FILM	2W 3.9 OHM J
R118	RS02Z100J-	R M-OXIDE FILM	2W 10 OHM J (TAPPING)
R407	RS01Z109J-	R M-OXIDE FILM	1W 1 OHM J (TAPPING)
R408	RS02Z479J-	R M-OXIDE FILM	2W 4.7 OHM J (TAPPING)
R518	RS01Z101J-	R M-OXIDE FILM	1W 100 OHM J (TAPPING)
R520	RS01Z159J-	R M-OXIDE FILM	1W 1.5 OHM J (TAPPING)
R529	RS01Z159J-	R M-OXIDE FILM	1W 1.5 OHM J (TAPPING)
R532	RS01Z101J-	R M-OXIDE FILM	1W 100 OHM J (TAPPING)
R554	RS01Z471J-	R M-OXIDE FILM	1W 470 OHM J (TAPPING)
R573	RS01Z470J-	R M-OXIDE FILM	1W 47 OHM J (TAPPING)
R587	RS02Z102J-	R M-OXIDE FILM	2W 1K OHM J (TAPPING)
R589	RW01Z308JN	R WIRE WOUND	1W 0.30 OHM J NON-INDUCT
R603	RS02Z331J-	R M-OXIDE FILM	2W 330 OHM J TAPPING
R604	RW01Z308JN	R WIRE WOUND	1W 0.30 OHM J NON-INDUCT
R631	RS02Z129J-	R M-OXIDE FILM	2W 1.2 OHM J (TAPPING)
R632	RS02Z129J-	R M-OXIDE FILM	2W 1.2 OHM J (TAPPING)
R633	RS02Z129J-	R M-OXIDE FILM	2W 1.2 OHM J (TAPPING)
R755	RS01Z104J-	R M-OXIDE FILM	1W 100K OHM J (TAPPING)
R756	RS01Z104J-	R M-OXIDE FILM	1W 100K OHM J (TAPPING)
R757	RS01Z104J-	R M-OXIDE FILM	1W 100K OHM J (TAPPING)
SW201	5S50101Z01	SW TACT	KPT-1115VM 1C-1P
SW202	5S50101Z01	SW TACT	KPT-1115VM 1C-1P
SW203	5S50101Z01	SW TACT	KPT-1115VM 1C-1P
SW204	5S50101Z01	SW TACT	KPT-1115VM 1C-1P
VR551	RV6421503P	R SEMI FIXED	CCT 065AT 50K OHM B TAP
VR601	RV6121202P	R SEMI FIXED	CCT 063BT 2K OHM B TAP
50010	PCMPJRJ046	PCB MAIN RADIAL AS	CMC-710B
C005	CEXF1H101V	C ELECTRO	50V RSS 100MF (8X11.5) TP

LOC	PART-CODE	PART-NAME	PART-DESC
C011	CEXF1H109V	C ELECTRO	50V RSS 1MF (5X11) TP
C013	CEXF1H109V	C ELECTRO	50V RSS 1MF (5X11) TP
C014	CCXF1H223Z	C CERA	50V F 0.022MF Z (TAPPING)
C105	CEXF1C101V	C ELECTRO	16V RSS 100MF (6.3X11) TP
C107	CCXF1H223Z	C CERA	50V F 0.022MF Z (TAPPING)
C108	CEXF1C101V	C ELECTRO	16V RSS 100MF (6.3X11) TP
C109	CEXF1C101V	C ELECTRO	16V RSS 100MF (6.3X11) TP
C110	CEXF1C221V	C ELECTRO	16V RSS 220MF (8X11.5) TP
C111	CEXF1H100V	C ELECTRO	50V RSS 10MF (5X11) TP
C112	CMXM2A104J	C MYLAR	100V 0.1MF J (TP)
C114	CEXF1C101V	C ELECTRO	16V RSS 100MF (6.3X11) TP
C118	CCXB2H102K	C CERA	500V B 1000PF K (TAPPING)
C202	CEXF1C101V	C ELECTRO	16V RSS 100MF (6.3X11) TP
C209	CCXB1H221K	C CERA	50V B 220PF K (TAPPING)
C210	CCXB1H221K	C CERA	50V B 220PF K (TAPPING)
C211	CEXF1H100V	C ELECTRO	50V RSS 10MF (5X11) TP
C266	CMXM2A104J	C MYLAR	100V 0.1MF J (TP)
C267	CEXD1H220F	C ELECTRO	50V RND 22MF (10*11.5)
C271	CEXF1H100V	C ELECTRO	50V RSS 10MF (5X11) TP
C276	CEXF1H100V	C ELECTRO	50V RSS 10MF (5X11) TP
C277	CEXF1H100V	C ELECTRO	50V RSS 10MF (5X11) TP
C278	CEXF1H100V	C ELECTRO	50V RSS 10MF (5X11) TP
C279	CEXF1H100V	C ELECTRO	50V RSS 10MF (5X11) TP
C281	CEXF1H100V	C ELECTRO	50V RSS 10MF (5X11) TP
C401	CMX12A154J	C MYLAR	MEU 100V 0.15MF J(TP)
C404	CEXF1E470V	C ELECTRO	25V RSS 47MF (5X11) TP
C405	CEXF1C221V	C ELECTRO	16V RSS 220MF (8X11.5) TP
C407	CEXF1H101V	C ELECTRO	50V RSS 100MF (8X11.5) TP
C408	CCXB1H471K	C CERA	50V B 470PF K (TAPPING)
C410	CCXF1H104Z	C CERA	50V F 0.1MF Z
C411	CMXM2A562J	C MYLAR	100V 5600PF J (TP)
C417	CCXF1H104Z	C CERA	50V F 0.1MF Z
C504	CMXM2A182J	C MYLAR	100V 1800PF J (TP)
C505	CEXF1H479V	C ELECTRO	50V RSS 4.7MF (5X11) TP
C509	CCXF1H104Z	C CERA	50V F 0.1MF Z
C510	CEXF1E470V	C ELECTRO	25V RSS 47MF (5X11) TP
C511	CCXB1H102K	C CERA	50V B 1000PF K (TAPPING)
C512	CEXF1H339V	C ELECTRO	50V RSS 3.3MF (5X11) TP
C513	CMXM2A392J	C MYLAR	100V 3900PF J (TP)
C514	CEXF1H109V	C ELECTRO	50V RSS 1MF (5X11) TP

LOC	PART-CODE	PART-NAME	PART-DESC
C515	CMXM2A104J	C MYLAR	100V 0.1MF J (TP)
C516	CCXF1H104Z	C CERA	50V F 0.1MF Z
C517	CEXF2A100V	C ELECTRO	100V RSS 10MF (6.3X11) TP
C518	CMXM2A104J	C MYLAR	100V 0.1MF J (TP)
C525	CEXF1H100V	C ELECTRO	50V RSS 10MF (5X11) TP
C528	CEXF1H229V	C ELECTRO	50V RSS 2.2MF (5X11) TP
C533	CEXF1C101V	C ELECTRO	16V RSS 100MF (6.3X11) TP
C554	CCXB2H102K	C CERA	500V B 1000PF K (TAPPING)
C556	CMXM2A104J	C MYLAR	100V 0.1MF J (TP)
C570	CEXF1H100V	C ELECTRO	50V RSS 10MF (5X11) TP
C572	CEXF1C221V	C ELECTRO	16V RSS 220MF (8X11.5) TP
C573	CEXF1C101V	C ELECTRO	16V RSS 100MF (6.3X11) TP
C577	CMXM2A562J	C MYLAR	100V 5600PF J (TP)
C579	CEXF1C470V	C ELECTRO	16V RSS 47MF (5X11) TP
C580	CEXF1C101V	C ELECTRO	16V RSS 100MF (6.3X11) TP
C583	CCXB2H471K	C CERA	500V B 470PF K (TAPPING)
C586	CEXF1H100V	C ELECTRO	50V RSS 10MF (5X11) TP
C591	CMXM2A104J	C MYLAR	100V 0.1MF J (TP)
C593	CEXF1H339V	C ELECTRO	50V RSS 3.3MF (5X11) TP
C601	CEXF1H109V	C ELECTRO	50V RSS 1MF (5X11) TP
C603	CCXB2H102K	C CERA	500V B 1000PF K (TAPPING)
C606	CMXM2A473J	C MYLAR	100V 0.047MF J (TP)
C751	CEXF1H100V	C ELECTRO	50V RSS 10MF (5X11) TP
C801	CEXF1H100V	C ELECTRO	50V RSS 10MF (5X11) TP
C804	CEXF1C470V	C ELECTRO	16V RSS 47MF (5X11) TP
C808	CEXF1C470V	C ELECTRO	16V RSS 47MF (5X11) TP
C811	CEXF1C220V	C ELECTRO	RSS 16V 22MF 5*11
C831	CEXF1H100V	C ELECTRO	50V RSS 10MF (5X11) TP
C861	CEXF1H100V	C ELECTRO	50V RSS 10MF (5X11) TP
C880	CEXF1H101V	C ELECTRO	50V RSS 100MF (8X11.5) TP
C901	CMXM2A473J	C MYLAR	100V 0.047MF J (TP)
C996	CEXF1C220V	C ELECTRO	RSS 16V 22MF 5*11
C998	CEXF1H100V	C ELECTRO	50V RSS 10MF (5X11) TP
F001A	9977410900	FUSE CLIP	BSP3-H T0.4 SN 5.2
F001B	9977410900	FUSE CLIP	BSP3-H T0.4 SN 5.2
IC101	1KA431ZTA-	IC SHUNT	KA431ZTA
IC202	1KA7542---	IC VOTAGE DETECTOR	KA7542
Q102	TKSD471ACY	TR	KSD471ACY
Q103	TKTA1273Y-	TR	KTA1273-Y
Q104	TZSR1006--	TR	KSR1006 (AUTO)

LOC	PART-CODE	PART-NAME	PART-DESC
Q201	TKSD471ACY	TR	KSD471ACY
Q202	TKSD471ACY	TR	KSD471ACY
Q203	TZSR1006--	TR	KSR1006 (AUTO)
Q204	TZSR1006--	TR	KSR1006 (AUTO)
Q501	TKSD471ACY	TR	KSD471ACY
Q502	TKSA539CY-	TR	KSA539CY
Q516	TKSA539CY-	TR	KSA539CY
Q517	TZSR1006--	TR	KSR1006 (AUTO)
Q525	TZTA1270Y-	TR	KTA1270Y(AUTO)(562Y)
Q553	TZSR1006--	TR	KSR1006 (AUTO)
Q556	TZSR1006--	TR	KSR1006 (AUTO)
Q557	TZSR1006--	TR	KSR1006 (AUTO)
Q558	TZSR1006--	TR	KSR1006 (AUTO)
Q571	T2N3904---	TR	2N3904
Q572	TKSD471ACY	TR	KSD471ACY
Q573	TKSA539CY-	TR	KSA539CY
Q575	TKSD471ACY	TR	KSD471ACY
Q601	TKSA539CY-	TR	KSA539CY
Q602	TKSD471ACY	TR	KSD471ACY
Q751	TKSP45----	TR	KSP45
Q752	TKSP92----	TR	KSP92
Q753	TKSP92----	TR	KSP92
Q754	TKSP45----	TR	KSP45
Q755	TKSP45----	TR	KSP45
Q756	TKSP45----	TR	KSP45
Q871	TZSR1006--	TR	KSR1006 (AUTO)
Q901	TKSA910Y--	TR	KSA910Y
Q902	TZSC945CY-	TR	KSC945C-Y (AUTO)
Q903	TKSD471ACY	TR	KSD471ACY
Q904	TKSA539CY-	TR	KSA539CY
Q905	TZSR1009--	TR	KSR1009
X201	5XJ6R0000E	CRYSTAL QUARTZ	HC-49/S 6MHZ 22PF 30PPM
60010	PCMPJAJ046	PCB MAIN AXIAL AS	CMC-710B
A0001	9979800462	PCB MAIN	T1.6*330*246
B001	5PB13857--	COIL BEAD	BI3857(AXIAL)
B002	5PB13857--	COIL BEAD	BI3857(AXIAL)
B101	5PB13857--	COIL BEAD	BI3857(AXIAL)
B175	5PB13857--	COIL BEAD	BI3857(AXIAL)
B345	5PB13857--	COIL BEAD	BI3857(AXIAL)
B381	5PB13857--	COIL BEAD	BI3857(AXIAL)

LOC	PART-CODE	PART-NAME	PART-DESC
B881	5PB13857--	COIL BEAD	BI3857(AXIAL)
C009	CCZB1H102K	C CERA	50V B 1000PF K
C201	CCZB1H181K	C CERA	50V B 180PF K
C207	CCZB1H221K	C CERA	50V B 220PF K
C208	CCZB1H221K	C CERA	50V B 220PF K
C214	CCZF1H104Z	C CERA	50V HIKF 0.1MF Z
C246	CCZF1H104Z	C CERA	50V HIKF 0.1MF Z
C501	CCZB1H101K	C CERA	50V B 100PF K
C524	CCZB1H471K	C CERA	50V B 470PF K
C534	CCZF1H104Z	C CERA	50V HIKF 0.1MF Z
C548	CCZB1H181K	C CERA	50V B 180PF K
C571	CCZB1H471K	C CERA	50V B 470PF K
C575	CCZB1H103K	C CERA	HIKB 50V 0.01MF K AXIAL
C576	CCZB1H102K	C CERA	50V B 1000PF K
C752	CCZF1H104Z	C CERA	50V HIKF 0.1MF Z
C903	CCZB1H103K	C CERA	HIKB 50V 0.01MF K AXIAL
C941	CCZB1H102K	C CERA	50V B 1000PF K
C994	CCZF1H104Z	C CERA	50V HIKF 0.1MF Z
C995	CCZF1H104Z	C CERA	50V HIKF 0.1MF Z
C997	CCZB1H152K	C CERA	50V B 1500PF K (AXIAL)
C999	CCZF1H104Z	C CERA	50V HIKF 0.1MF Z
DZ001	DDZ4R3BM--	DIODE ZENER	DZ4.3BM
DZ008	DDZ8R2BM--	DIODE ZENER	DZ8.2BM
DZ201	DDZ5R1B---	DIODE ZENER	DZ-5.1B
DZ202	DDZ5R1B---	DIODE ZENER	DZ-5.1B
DZ203	DDZ5R1B---	DIODE ZENER	DZ-5.1B
DZ401	DDZ5R1B---	DIODE ZENER	DZ-5.1B
DZ501	DDZ5R1B---	DIODE ZENER	DZ-5.1B
DZ571	DDZ5R1B---	DIODE ZENER	DZ-5.1B
DZ581	DDZ15BM---	DIODE ZENER	DZ15BM
D012	DZN4148---	DIODE	1N4148 AUTO 52MM
D107	DZN4148---	DIODE	1N4148 AUTO 52MM
D206	DZN4148---	DIODE	1N4148 AUTO 52MM
D207	DZN4148---	DIODE	1N4148 AUTO 52MM
D209	DZN4148---	DIODE	1N4148 AUTO 52MM
D503	DZN4148---	DIODE	1N4148 AUTO 52MM
D525	DZN4148---	DIODE	1N4148 AUTO 52MM
D531	DZN4148---	DIODE	1N4148 AUTO 52MM
D532	DZN4148---	DIODE	1N4148 AUTO 52MM
D571	DZN4148---	DIODE	1N4148 AUTO 52MM

LOC	PART-CODE	PART-NAME	PART-DESC
D572	DZN4148---	DIODE	1N4148 AUTO 52MM
D574	DZN4148---	DIODE	1N4148 AUTO 52MM
D578	DFDH400---	DIODE	FDH400
D601	DZN4148---	DIODE	1N4148 AUTO 52MM
D604	DZN4148---	DIODE	1N4148 AUTO 52MM
D751	DZN4148---	DIODE	1N4148 AUTO 52MM
D752	DZN4148---	DIODE	1N4148 AUTO 52MM
D753	DZN4148---	DIODE	1N4148 AUTO 52MM
D754	DZN4148---	DIODE	1N4148 AUTO 52MM
D755	DZN4148---	DIODE	1N4148 AUTO 52MM
D756	DZN4148---	DIODE	1N4148 AUTO 52MM
D757	DZN4148---	DIODE	1N4148 AUTO 52MM
D801	DZN4148---	DIODE	1N4148 AUTO 52MM
D802	DZN4148---	DIODE	1N4148 AUTO 52MM
D831	DZN4148---	DIODE	1N4148 AUTO 52MM
D832	DZN4148---	DIODE	1N4148 AUTO 52MM
D861	DZN4148---	DIODE	1N4148 AUTO 52MM
D862	DZN4148---	DIODE	1N4148 AUTO 52MM
D901	DZN4148---	DIODE	1N4148 AUTO 52MM
D902	DZN4148---	DIODE	1N4148 AUTO 52MM
D912	DZN4148---	DIODE	1N4148 AUTO 52MM
J411	RD-AZ101J-	R CARBON FILM	1/6 100 OHM J
L881	5CPZ101K02	COIL PEAKING	100UH K (AXIAL 3.5MM)
R001	RD-2Z105J-	R CARBON FILM	1/2 1M OHM J
R010	RD-4Z101J-	R CARBON FILM	1/4 100 OHM J
R102	RD-4Z201J-	R CARBON FILM	1/4 200 OHM J
R105	RD-AZ222J-	R CARBON FILM	1/6 2.2K OHM J
R106	RD-AZ511J-	R CARBON FILM	1/6 510 OHM J
R108	RN-AZ2102F	R METAL FILM	1/6 21K OHM F
R111	RD-AZ102J-	R CARBON FILM	1/6 1K OHM J
R112	RD-AZ153J-	R CARBON FILM	1/6 15K OHM J
R113	RD-AZ102J-	R CARBON FILM	1/6 1K OHM J
R115	RN-AZ1211F	R METAL FILM	1/6 1.21K OHM F
R116	RD-AZ472J-	R CARBON FILM	1/6 4.7K OHM J
R201	RD-AZ333J-	R CARBON FILM	1/6 33K OHM J
R202	RD-AZ472J-	R CARBON FILM	1/6 4.7K OHM J
R203	RD-AZ911J-	R CARBON FILM	1/6 910 OHM J
R204	RD-AZ122J-	R CARBON FILM	1/6 1.2K OHM J
R207	RD-AZ472J-	R CARBON FILM	1/6 4.7K OHM J
R211	RN-AZ1212F	R METAL FILM	1/6 12.1K OHM F

LOC	PART-CODE	PART-NAME	PART-DESC
R212	RN-AZ9091F	R METAL FILM	1/6 9.09K OHM F
R213	RN-AZ8252F	R METAL FILM	1/6 82.5K OHM F
R214	RN-AZ1502F	R METAL FILM	1/6 15K OHM F
R215	RN-AZ3012F	R METAL FILM	1/6 30.1K OHM F
R226	RD-AZ101J-	R CARBON FILM	1/6 100 OHM J
R227	RD-AZ101J-	R CARBON FILM	1/6 100 OHM J
R229	RD-AZ222J-	R CARBON FILM	1/6 2.2K OHM J
R230	RD-AZ222J-	R CARBON FILM	1/6 2.2K OHM J
R231	RD-AZ222J-	R CARBON FILM	1/6 2.2K OHM J
R232	RD-AZ750J-	R CARBON FILM	1/6 75 OHM J
R241	RD-AZ472J-	R CARBON FILM	1/6 4.7K OHM J
R249	RD-AZ101J-	R CARBON FILM	1/6 100 OHM J
R250	RD-AZ101J-	R CARBON FILM	1/6 100 OHM J
R281	RD-AZ472J-	R CARBON FILM	1/6 4.7K OHM J
R282	RD-AZ472J-	R CARBON FILM	1/6 4.7K OHM J
R283	RD-AZ472J-	R CARBON FILM	1/6 4.7K OHM J
R293	RD-AZ122J-	R CARBON FILM	1/6 1.2K OHM J
R294	RD-AZ563J-	R CARBON FILM	1/6 56K OHM J
R295	RD-AZ331J-	R CARBON FILM	1/6 330 OHM J
R296	RD-AZ331J-	R CARBON FILM	1/6 330 OHM J
R401	RD-AZ102J-	R CARBON FILM	1/6 1K OHM J
R402	RD-AZ103J-	R CARBON FILM	1/6 10K OHM J
R403	RN-AZ1002F	R METAL FILM	1/6 10K OHM F
R405	RN-AZ2211F	R METAL FILM	1/6 2.21K OHM F
R406	RN-4Z4000F	R METAL FILM	1/4W 400 OHM F
R410	RN-AZ5601F	R METAL FILM	1/6 5.6K OHM F
R411	RD-2Z229J-	R CARBON FILM	1/2 2.2 OHM J
R412	RD-2Z209J-	R CARBON FILM	1/2 2 OHM J
R501	RD-AZ102J-	R CARBON FILM	1/6 1K OHM J
R503	RD-AZ182J-	R CARBON FILM	1/6 1.8K OHM J
R504	RD-AZ122J-	R CARBON FILM	1/6 1.2K OHM J
R507	RD-AZ102J-	R CARBON FILM	1/6 1K OHM J
R509	RD-AZ361J-	R CARBON FILM	1/6 360 OHM J
R510	RD-AZ183J-	R CARBON FILM	1/6 18K OHM J
R511	RD-AZ333J-	R CARBON FILM	1/6 33K OHM J
R512	RD-AZ474J-	R CARBON FILM	1/6 470K OHM J
R514	RD-AZ563J-	R CARBON FILM	1/6 56K OHM J
R519	RD-AZ472J-	R CARBON FILM	1/6 4.7K OHM J
R521	RD-4Z200J-	R CARBON FILM	1/4 20 OHM J

LOC	PART-CODE	PART-NAME	PART-DESC
R522	RD-AZ203J-	R CARBON FILM	1/6 20K OHM J
R524	RD-4Z101J-	R CARBON FILM	1/4 100 OHM J
R525	RD-4Z121J-	R CARBON FILM	1/4 120 OHM J
R526	RD-AZ473J-	R CARBON FILM	1/6 47K OHM J
R527	RD-4Z433J-	R CARBON FILM	1/4 43K OHM J
R533	RD-AZ472J-	R CARBON FILM	1/6 4.7K OHM J
R535	RD-AZ473J-	R CARBON FILM	1/6 47K OHM J
R541	RD-AZ331J-	R CARBON FILM	1/6 330 OHM J
R543	RD-AZ331J-	R CARBON FILM	1/6 330 OHM J
R545	RD-AZ331J-	R CARBON FILM	1/6 330 OHM J
R551	RD-4Z100J-	R CARBON FILM	1/4 10 OHM J
R552	RD-AZ473J-	R CARBON FILM	1/6 47K OHM J
R553	RD-AZ102J-	R CARBON FILM	1/6 1K OHM J
R556	RD-AZ109J-	R CARBON FILM	1/6 1 OHM J
R557	RD-AZ102J-	R CARBON FILM	1/6 1K OHM J
R558	RD-AZ102J-	R CARBON FILM	1/6 1K OHM J
R559	RD-AZ102J-	R CARBON FILM	1/6 1K OHM J
R560	RD-AZ472J-	R CARBON FILM	1/6 4.7K OHM J
R561	RD-AZ472J-	R CARBON FILM	1/6 4.7K OHM J
R562	RD-AZ472J-	R CARBON FILM	1/6 4.7K OHM J
R571	RD-4Z471J-	R CARBON FILM	1/4 470 OHM J
R572	RD-AZ102J-	R CARBON FILM	1/6 1K OHM J
R574	RD-2Z100J-	R CARBON FILM	1/2 10 OHM J
R575	RD-4Z279J-	R CARBON FILM	1/4 2.7 OHM J
R577	RD-4Z470J-	R CARBON FILM	1/4 47 OHM J
R578	RD-4Z109J-	R CARBON FILM	1/4 1 OHM J
R579	RD-AZ822J-	R CARBON FILM	1/6 8.2K OHM J
R580	RD-AZ332J-	R CARBON FILM	1/6 3.3K OHM J
R582	RD-AZ822J-	R CARBON FILM	1/6 8.2K OHM J
R583	RD-AZ104J-	R CARBON FILM	1/6 100K OHM J
R584	RD-AZ102J-	R CARBON FILM	1/6 1K OHM J
R585	RD-AZ332J-	R CARBON FILM	1/6 3.3K OHM J
R586	RD-4Z229J-	R CARBON FILM	1/4 2.2 OHM J
R591	RN-AZ9092F	R METAL FILM	1/6 90.9K OHM F
R592	RD-AZ512J-	R CARBON FILM	1/6 5.1K OHM J
R594	RD-AZ512J-	R CARBON FILM	1/6 5.1K OHM J
R601	RD-AZ105J-	R CARBON FILM	1/6 1M OHM J
R602	RD-2Z100J-	R CARBON FILM	1/2 10 OHM J
R605	RD-AZ203J-	R CARBON FILM	1/6 20K OHM J
R606	RD-AZ392J-	R CARBON FILM	1/6 3.9K OHM J

LOC	PART-CODE	PART-NAME	PART-DESC
R607	RD-AZ153J-	R CARBON FILM	1/6 15K OHM J
R611	RD-AZ103J-	R CARBON FILM	1/6 10K OHM J
R751	RD-AZ153J-	R CARBON FILM	1/6 15K OHM J
R752	RD-AZ332J-	R CARBON FILM	1/6 3.3K OHM J
R758	RD-2Z202J-	R CARBON FILM	1/2 2K OHM J
R759	RD-2Z202J-	R CARBON FILM	1/2 2K OHM J
R802	RD-AZ101J-	R CARBON FILM	1/6 100 OHM J
R803	RD-AZ330J-	R CARBON FILM	1/6 33 OHM J
R814	RD-AZ100J-	R CARBON FILM	1/6 10 OHM J
R832	RD-AZ101J-	R CARBON FILM	1/6 100 OHM J
R833	RD-AZ330J-	R CARBON FILM	1/6 33 OHM J
R844	RD-AZ100J-	R CARBON FILM	1/6 10 OHM J
R855	RD-AZ472J-	R CARBON FILM	1/6 4.7K OHM J
R862	RD-AZ101J-	R CARBON FILM	1/6 100 OHM J
R863	RD-AZ330J-	R CARBON FILM	1/6 33 OHM J
R874	RD-AZ100J-	R CARBON FILM	1/6 10 OHM J
R881	RD-AZ472J-	R CARBON FILM	1/6 4.7K OHM J
R902	RD-AZ154J-	R CARBON FILM	1/6 150K OHM J
R903	RD-AZ623J-	R CARBON FILM	1/6 62K OHM J
R904	RD-AZ472J-	R CARBON FILM	1/6 4.7K OHM J
R905	RD-AZ752J-	R CARBON FILM	1/6 7.5K OHM J
R906	RD-AZ204J-	R CARBON FILM	1/6 200K OHM J
R907	RD-AZ473J-	R CARBON FILM	1/6 47K OHM J
R908	RD-AZ472J-	R CARBON FILM	1/6 4.7K OHM J
R909	RD-AZ202J-	R CARBON FILM	1/6 2K OHM J
R910	RD-AZ562J-	R CARBON FILM	1/6 5.6K OHM J
R911	RD-AZ303J-	R CARBON FILM	1/6 30K OHM J
R916	RD-AZ563J-	R CARBON FILM	1/6 56K OHM J
R935	RD-AZ823J-	R CARBON FILM	1/6 82K OHM J
R937	RD-AZ333J-	R CARBON FILM	1/6 33K OHM J
R939	RD-AZ104J-	R CARBON FILM	1/6 100K OHM J
R940	RD-AZ104J-	R CARBON FILM	1/6 100K OHM J
R941	RD-AZ242J-	R CARBON FILM	1/6 2.4K OHM J
R943	RD-AZ471J-	R CARBON FILM	1/6 470 OHM J
R944	RD-AZ471J-	R CARBON FILM	1/6 470 OHM J
R945	RD-AZ182J-	R CARBON FILM	1/6 1.8K OHM J
R946	RD-AZ101J-	R CARBON FILM	1/6 100 OHM J
R947	RD-AZ272J-	R CARBON FILM	1/6 2.7K OHM J
R994	RD-AZ821J-	R CARBON FILM	1/6 820 OHM J
R997	RD-AZ101J-	R CARBON FILM	1/6 100 OHM J

LOC	PART-CODE	PART-NAME	PART-DESC
R998	RD-AZ471J-	R CARBON FILM	1/6 470 OHM J
R999	RD-AZ433J-	R CARBON FILM	1/6 43K OHM J
TP1	85801052GY	WIRE COPPER	1/0.52 TIN COATING
30020	PCCTSWJ046	PCB CRT AS	CMC-710B
CA804	9970710181	CONN AS	1015#18+35068-9812=110
CA805	9970710181	CONN AS	1015#18+35068-9812=110
CT801	9979300008	SOCKET CRT	033 0 7700 44
CW801	9979220025	CONN WAFER	SMAW250-10 (ANGLE)
CW802	9979220022	CONN WAFER	SMAW250-07 (ANGLE)
C851	CMXM2A224J	C MYLAR	100V 0.22MF J
C891	CCXE3D103P	C CERA	HIKE 2KV 0.01MF P
C892	CCXB3D471K	C CERA	2KV B 470PF K (TAPPING)
CA803	9970710179	CONN AS	1015#18+4.3PIEX2=160
IC803	1LM2407T--	IC VIDEO OUTPUT	LM2407T
P11	4859242220	CONN WAFER	YFW800-02
SC801	9977410800	TERMINAL PIN	BSP1(SN) L=15MM
SG891	4SG0D00104	SPARK GAP	S-23 1.5KV
40010	PCCTJRJ046	PCB CRT RADIAL AS	CMC-710B
C805	CEXD1H109F	C ELECTRO	50V RND 1MF (5X11) TP
C806	CMXM2A222J	C MYLAR	100V 2200PF J (TP)
C807	CMXM2A333J	C MYLAR	100V 0.033MF J (TP)
C821	CCXF1H104Z	C CERA	50V F 0.1MF Z
C822	CEXF1E101V	C ELECTRO	25V RSS 100MF (6.3X11) TP
C835	CEXD1H109F	C ELECTRO	50V RND 1MF (5X11) TP
C836	CMXM2A222J	C MYLAR	100V 2200PF J (TP)
C837	CMXM2A333J	C MYLAR	100V 0.033MF J (TP)
C852	CEXF2A470V	C ELECTRO	100V RSS 47MF (10X16) TP
C865	CEXD1H109F	C ELECTRO	50V RND 1MF (5X11) TP
C866	CMXM2A222J	C MYLAR	100V 2200PF J (TP)
C867	CMXM2A333J	C MYLAR	100V 0.033MF J (TP)
C893	CCXB1H103K	C CERA	50V B 0.01MF K
C894	CCXB1H102K	C CERA	50V B 1000PF K (TAPPING)
C895	CEXF2A220V	C ELECTRO	100V RSS 22MF (8*11.5)
Q805	TKSC1009Y-	TR	KSC-1009-Y
Q806	TKSA910Y--	TR	KSA910Y
Q835	TKSC1009Y-	TR	KSC-1009-Y
Q836	TKSA910Y--	TR	KSA910Y
Q865	TKSC1009Y-	TR	KSC-1009-Y
Q866	TKSA910Y--	TR	KSA910Y
50010	PCCTJAJ046	PCB CRT AXIAL AS	CMC-710B

LOC	PART-CODE	PART-NAME	PART-DESC
B0001	9979800463	PCB VIDEO	T1.6*244*246
B803	5PB13857--	COIL BEAD	BI3857(AXIAL)
B805	5PB13857--	COIL BEAD	BI3857(AXIAL)
B811	5PB13857--	COIL BEAD	BI3857(AXIAL)
B812	5PB13857--	COIL BEAD	BI3857(AXIAL)
B813	5PB13857--	COIL BEAD	BI3857(AXIAL)
B814	5PB13857--	COIL BEAD	BI3857(AXIAL)
B859	5PB13857--	COIL BEAD	BI3857(AXIAL)
B863	5PB13857--	COIL BEAD	BI3857(AXIAL)
B864	5PB13857--	COIL BEAD	BI3857(AXIAL)
D803	DFDH400---	DIODE	FDH400
D804	DFDH400---	DIODE	FDH400
D805	DFDH400---	DIODE	FDH400
D833	DFDH400---	DIODE	FDH400
D834	DFDH400---	DIODE	FDH400
D835	DFDH400---	DIODE	FDH400
D863	DFDH400---	DIODE	FDH400
D864	DFDH400---	DIODE	FDH400
D865	DFDH400---	DIODE	FDH400
L801	5CPZ568K02	COIL PEAKING	0.56UH K (AXIAL 3.5MM)
L831	5CPZ568K02	COIL PEAKING	0.56UH K (AXIAL 3.5MM)
L861	5CPZ568K02	COIL PEAKING	0.56UH K (AXIAL 3.5MM)
R804	RD-4Z271J-	R CARBON FILM	1/4 270 OHM J
R805	RD-4Z101J-	R CARBON FILM	1/4 100 OHM J
R807	RC-2Z470J-	R CARBON COMP	1/2 47 OHM J
R808	RD-AZ133J-	R CARBON FILM	1/6 13K OHM J
R809	RD-AZ683J-	R CARBON FILM	1/6 68K OHM J
R810	RD-AZ224J-	R CARBON FILM	1/6 220K OHM J
R811	RD-AZ154J-	R CARBON FILM	1/6 150K OHM J
R812	RD-AZ474J-	R CARBON FILM	1/6 470K OHM J
R822	RD-2Z104J-	R CARBON FILM	1/2 100K OHM J
R834	RD-4Z271J-	R CARBON FILM	1/4 270 OHM J
R835	RD-4Z101J-	R CARBON FILM	1/4 100 OHM J
R837	RC-2Z470J-	R CARBON COMP	1/2 47 OHM J
R838	RD-AZ133J-	R CARBON FILM	1/6 13K OHM J
R839	RD-AZ683J-	R CARBON FILM	1/6 68K OHM J
R840	RD-AZ224J-	R CARBON FILM	1/6 220K OHM J
R841	RD-AZ154J-	R CARBON FILM	1/6 150K OHM J
R842	RD-AZ474J-	R CARBON FILM	1/6 470K OHM J
R852	RD-2Z104J-	R CARBON FILM	1/2 100K OHM J

LOC	PART-CODE	PART-NAME	PART-DESC
R864	RD-4Z271J-	R CARBON FILM	1/4 270 OHM J
R865	RD-4Z101J-	R CARBON FILM	1/4 100 OHM J
R867	RC-2Z470J-	R CARBON COMP	1/2 47 OHM J
R868	RD-AZ133J-	R CARBON FILM	1/6 13K OHM J
R869	RD-AZ683J-	R CARBON FILM	1/6 68K OHM J
R870	RD-AZ224J-	R CARBON FILM	1/6 220K OHM J
R871	RD-AZ154J-	R CARBON FILM	1/6 150K OHM J
R872	RD-AZ474J-	R CARBON FILM	1/6 470K OHM J
R882	RD-2Z104J-	R CARBON FILM	1/2 100K OHM J
R891	RD-4Z562J-	R CARBON FILM	1/4 5.6K OHM J
R892	RD-4Z564J-	R CARBON FILM	1/4 560K OHM J
R893	RD-AZ103J-	R CARBON FILM	1/6 10K OHM J
SG801	DWSP201M--	SURGE ABSORBER	WSP-201M
SG831	DWSP201M--	SURGE ABSORBER	WSP-201M
SG861	DWSP201M--	SURGE ABSORBER	WSP-201M

DAEWOO

DAEWOO ELECTRONICS CO., LTD
686, AHYEON-DONG MAPOGU,
SEOUL, KOREA.
C.P.O. BOX 8003 SEOUL KOREA
TELEX: DWELEC K28177-8
CABLE: "DAEWOOELEC"

<http://www.dwe.co.kr>

PRINTED DATE: NOV.1998